



Catalogue

with European market established renewable,
energy efficient and energy saving solutions
of our SMEs for a quick uptake by industry,
communal authorities and cities

Enterprise Europe Network (EEN)

EEN Energy Task Force – Sector Group Renewable Energy

Catalogue with European market established renewable, energy efficient and energy saving solutions of our SMEs for a quick uptake by industry, communal authorities and cities

Due to the current high-price situation for energy, small and medium-sized enterprises (SMEs) across Europe are under great pressure to reduce their energy consumption, to become more energy efficient and/or to make use of carbon neutral renewable energies by replacing climate damaging fossil fuels.

Not only are European SMEs under pressure to develop strategies in order to master the necessary transformation of their energy systems; this is even more true for energy intensive industries, cities and municipalities.

Solutions to address these needs already exist and available on the market thanks to the enormous innovation potential and responsiveness of European SMEs.

Members of the “EEN Energy Task Force” and further energy experts of the Enterprise Europe Network have therefore decided to collect the technical and service solutions as offered by innovative SMEs across Europe, that perfectly cover the pressing needs of energy intensive industry, SMEs, cities and municipalities.

Around 70 intelligent solutions are shared within this catalogue. You are welcome to make use of it and share it further amongst enterprises, public institutions and stakeholder networks.

Apart from the technical and service solutions, additional information is available herein on EU funding opportunities that support the implementation of energy efficient/energy saving measures and/or renewable energies.

If you have any questions, please contact the persons indicated at the bottom of the profiles in the catalogue, or your local Enterprise Europe Network advisor:

<https://een.ec.europa.eu/local-contact-points>

How to find & get your solution?

You can find the energy solutions in the following categories (or you can browse them all):

Power Generation

- Renewable Electricity Generation
- Renewable Heat generation

Storage

- Electricity Storage
- Thermal Energy Storage

Mobility / Electric Vehicles

- Solution related to Clean Mobility
- Solutions for Electric Vehicles

Energy Efficiency for Buildings & Industrial Buildings

- Improving energy efficiency in buildings e.g. monitoring, behaviour or intelligence
- Improving energy efficiency in industrial buildings

Energy Efficiency for Cities & Communities

- Improving energy efficiency in cities & communities e.g. with smart systems in public spaces

Energy Efficiency for Electricity Production for Industrial Processes

- Improving energy efficiency in production of renewable energy
- Improving energy efficiency in industrial processes to reduce energy use.

How to get in contact with a company that could provide a solution you are interested in?

1. Have the solution of your interest on your screen.
2. Copy the title of this solution.
3. Click the email address at the bottom of the solution (email program opens with an email) and paste the title of the solution into the title of the email.
4. Write a brief outline of your request, ask for extra clarification or explain what is the need of your company the solution could possibly address.
5. Please add your contact details and send the email.
6. The EEN Advisor you have sent it to will respond to you directly.

The companies providing the solutions and the developers of this catalogue hope your company will benefit from one or more of the offered technologies or services.



Power generation

Renewable Electricity Generation

Renewable Heat generation

A technology to effectively utilize and recycle sewage sludge

Summary:

A Hungarian company has developed a patented technology that provides a solution for transforming municipal sewage sludge into solid fuel (Solid Recovered Fuel - SRF), which also enables sewage plants to achieve significant cost savings. The company is looking for potential licensing partners in the field of sewage plant construction and operation.

Advantages compared to current solutions:

- Payback period: 4-5 years;
- Quick dewatering as compared to other solutions.

Other advantages:

- Small size of units: 2t/day unit fits 2pcs. 20 feet containers;
- TÜV certified burning material pellet;
- Unique dewatering: using the end product to run the drying unit;
- The technology is also generating 3-4 workplaces per unit;
- It offers an economical solution to sewage sludge treatment for wastewater companies;
- The technology could be interesting for other partners too e.g. processing cattle manure waste into pellets.

Additional information, pictures etc.: <https://een.ec.europa.eu/b2b/details/5d803026-493b-4834-8060-018225384e7b>

Contact: Dr. András Kiss, kiss.andras@hbkik.hu

Feeding system and heat exchanger



Pre-dryer



Extruder



End-product

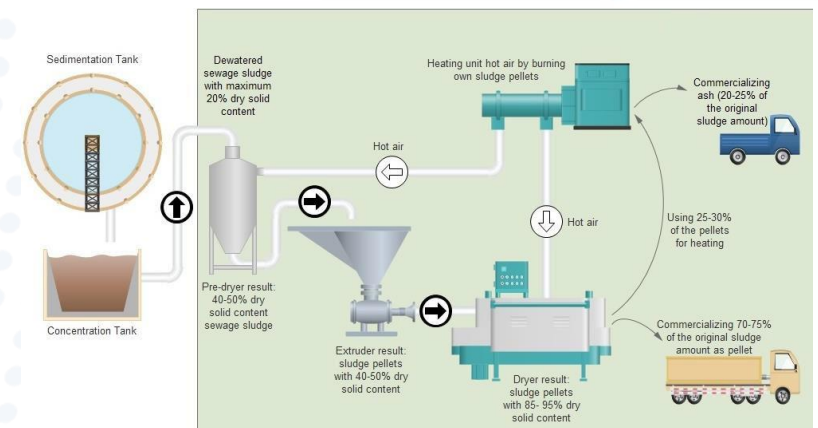

Clean electricity generation through a floating solar technology at near shore location

Summary:

A French company has developed a new wind and wave-resistant floating solar technology for near shore locations. The floating solar technology is already tested in the sea. The French company offers commercial agreement to interested partners as ports, marinas, utility companies and municipalities.

Advantages compared to current solutions:

- Cost reduction: electricity price is 2x less than electricity from the grid.
- Performance increase: 15% due to the cooling effect of water.
- Cost/Watt (EUR/Watt): 2000€/kWatt.

Other advantages:

- Floating solar system for near-shore location;
- Wind and wave-resistant technology thanks to a patented stability feature;
- Flexible and robust connectors;
- Passive and cooling system allowing a better efficiency of the solar panels;
- Machine Learning.



Additional information, pictures etc.: <https://een.ec.europa.eu/b2b/details/0bf40552-aa21-4060-b714-0180f9f9e4df>

Contact: Cendrine CARMAGNAC, c.carmagnac@solutions-eco.fr

With a foldable solar power plant, industrial and traffic areas can be used for the production of clean energy without restricting the primary use of the area

Summary:

A young company from Switzerland provides the answer of how renewable energy can be produced without harming nature and the landscape. With a foldable solar plant, large infrastructure areas are opened up for the production of solar power. In this way, sewage treatment plants, truck stands and parking spaces are used twice without restricting their primary use. Using open sewage treatment basins for solar power production in this way is unique in the world. The folding mechanism is patented.

Advantages compared to current solutions:



For parking and logistics areas:

- Cheaper construction thanks to 50% less material used than with fixed PV constructions;
- Use of the entire area incl. roadways for solar power production;
- Free traffic routes for trucks and lorries thanks to greater height and fewer supports;
- No loss of parking space thanks to wide distances between supports;
- Self-generated electricity, e.g. for electric vehicles, and independence from the grid;
- In summer, the shade cools the vehicles and the asphalt surface (less maintenance).



For wastewater treatment plants:

- Sewage treatment plants can become energy self-sufficient when combined (e.g. CHP);
- Always free access from above for maintenance and logistics;
- The shade reduces algae growth in the basins and protects employees from UV & heat.



Contact: Ernst-Jan van Hattum, ernst-jan.vanhattum@innosuisse.ch

Compact hybrid micro power plants for year-round sustainable energy generation based on wind and solar

Summary:

The plug & play micro power plants generate green electricity locally from the combination of high-performance wind dual turbines and solar panels mounted on a flexible wooden structure, which can be easily installed on roof tops of homes and commercial buildings and allow the generation of clean green energy in summer and winter, day and night, also in bad weather conditions. The Swiss company is looking for commercial agreements with technical expertise.

Advantages compared to current solutions:

- With only 4 square meter footprint, they provide the highest power per m2.

Other advantages:

- Wind and sun together can generate energy 365 days/nights a year;
- Vertical Axis Wind Turbines (VAWT) do not have to adjust to the wind direction and have higher efficiency in turbulent winds than Horizontal Axis Wind Turbines (HAWT);
- The wooden support structure makes a positive contribution to CO2;
- Power supply can be guaranteed in remote locations, avoiding transport of diesel etc.;
- When combining wind and solar power, fewer storage batteries are needed to achieve the same level of self-sufficiency, resulting in less critical material needed.



Additional information, pictures etc.: <https://een.ec.europa.eu/b2b/details/727729f8-cd2d-4c91-a604-01860cea4af3>

Contact: Ernst-Jan van Hattum, ernst-jan.vanhattum@innosuisse.ch

Thermal energy retrieved from surface and ground water via activated steel sheet pile walls

Summary:

An energy source that remains untapped: surface and ground water. Steel sheet pile walls allow buildings to be heated/cooled using this renewable source. The sheet piles are fitted with collectors and installed in the ground without interfering with the installation method. By means of heat pumps, buildings can be heated and cooled 24/7 throughout the year. When the electrical energy for the heat pump is supplied by sustainable sources, the entire system becomes energy and carbon neutral.

Advantages compared to current solutions:

- High performance: SCOP (Seasonal Coefficient of Performance) of 5,0 – 6,0 is possible, so return on investment within 5,0 - 7,0 years.

Other advantages:

- Significant contribution to CO2 reduction;
- Low installation costs because of installation of the elements into the ground via vibration, so no soil layers are disrupted. Steel components are 100% recyclable;
- Closed system, so no liquids are put into or extracted from the soil or surface water;
- Silent and no horizon pollution;
- Energy source available 24/7 throughout the year;
- Suitable as a heat and cooling source;
- Good scalable



Autonomous agricultural robots powered by clean renewable energy via solar panels

Summary:

An Italian company has developed a clean energy hardware and software architecture suitable for agriculture and outdoor robots. The robot is powered by rechargeable batteries with wireless induction recharge, avoiding the need for cables. Therefore, the solution allows the robot to be independent from the electrical grid, move freely and safely in the field, adopting energy efficient operation strategies and therefore maximising autonomy.

Advantages compared to current solutions:

The solution brings the following advantages compared to cabled robots powered from non-renewable energy:

- Be powered by rechargeable batteries from a renewable energy source;
- Wireless charging;
- Cutting operational costs by 70%, primarily by reducing energy bills;
- The ability to move autonomously and safely in the field, increasing the area covered per robot.

Other advantages:

- The robot can operate up to 8 consecutive hours on a field of 1000mq;
- Integration with weather forecast;
- Charging station can be moved in a convenient place.

Contact: Federico Molino, f.molino@pie.camcom.it

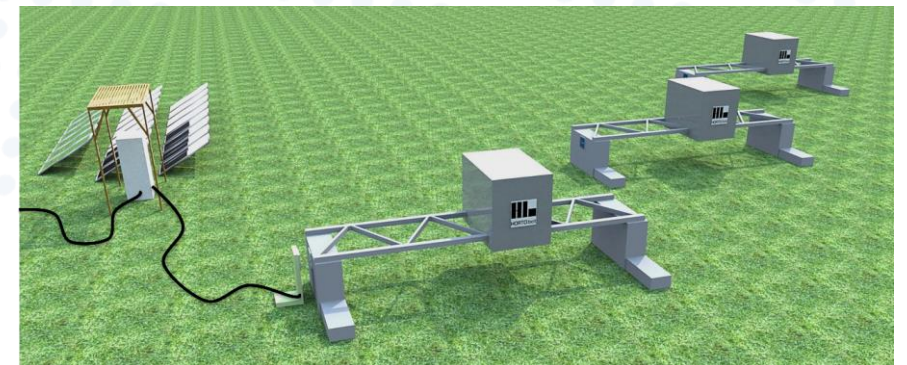
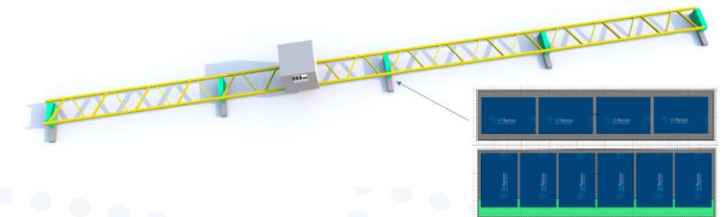

Sustainable osmotic energy from freshwater and seawater

Summary:

An Italian company has developed a clean energy hardware and software architecture suitable for agriculture and outdoor robots. The robot is powered by rechargeable batteries with wireless induction recharge, avoiding the need for cables. Therefore, the solution allows the robot to be independent from the electrical grid, move freely and safely in the field, adopting energy efficient operation strategies and therefore maximising autonomy.

Advantages compared to current solutions:

- Sustainable, clean energy without CO2 emissions;
- Available 24/7/365;
- Complements irregular wind or solar energy;
- Decreases storage costs due to 100% continuous generation;
- No significant environmental nor ecological impact;
- Going down the cost curve, the cost will go down from 11 €/ct/kWh in 2030 to 6 €/ct/kWh in 2050 adding up to 10% to the global energy demand as a base load.



Other advantages:

- Can be applied in industrial applications to reduce energy consumption in processes that have both salt and freshwater available, such as desalination plants in combination with wastewater treatment plants.



Contact: Brigitte Duffhues, b.duffhues@wateralliance.nl

Turning the power of water into a green, cheap and reliable source of energy with near zero environmental impact

Summary:

An Italian SME has developed a hydro micro-turbine specifically designed to turn the kinetic energy of waterways into electrical power. The turbine technology, has patented features and is suitable for applications on rivers and canals. Reliability and safety are ensured by accurate implementation throughout the plant lifecycle, from design, to operation. The SME is looking for partners to collaborate via commercial agreement with technical assistance.

Advantages compared to current solutions:

- LCOE (Levelized Cost of Energy) in a range between 40 and 80 €/MWh;
- Discounted payback between 7 and 13 years; the life cycle of the plant is 30 years.

Other advantages:

- Adaptability to almost all watercourses in their different shapes and sizes;
- Production: each plant can deliver from 1 to 200 kW. Several plants located in series along the watercourse allow to deliver hundreds of kW;
- Near zero environmental impact. No civil works; no noise as turbines work under water; no impact on waterway animals and plant life conservation; no water pollution.



Additional information: <https://een.ec.europa.eu/b2b/profile/0e56ead0-63bb-41c1-8133-01870ed55961>

Contact: Gabriella Cadeddu, gabriella.cadeddu@finlombarda.it

An innovative system to use energy from renewable sources in self-consumption mode

Summary:

An Italian SME has developed and patented a system allowing the use of electricity produced with renewable sources in self-consumption mode, so not using GRID-energy. By using the new system, any electricity device can easily be connected to local renewable generators (i.e. solar panels) and become more eco friendly by using renewable energy. A household will use their own generated energy themselves and the GRID will only add energy that is needed. For detailed information click on the link below on this page.

The company is looking for partners interested in using the solution in different areas, via a commercial agreement with technical assistance.

Advantages compared to current solutions:

- It maximizes the use of renewable source generators almost up to 100%, decreasing the use of fossil sources and increasing energy savings more than 20%;
- It allows a self-consumption mode, simplifying the renewable plant implementation;
- It manages the energy flow coming from different generators, and then feeds the load with the sum of them;
- It simplifies and speeds up the application of renewable energy source, since procedures to introduce electricity into the national grid are not required.



Additional information: <https://een.ec.europa.eu/b2b/profile/1b2dc666-f115-4f17-811f-0187238a4172>

Contact: Gabriella Cadeddu, gabriella.cadeddu@finlombarda.it

Photovoltaic system in combination with battery storage increases degree of self-sufficiency to over 80%

Summary:

A German company offers holistic energy solutions for commercial customers and private households. Based on photovoltaic systems the offered applications include new system construction (B2C), construction of new commercial systems, energy storage solutions, charging infrastructure (private and semi-public charging) for private and commercial customers, as well as repowering and repair of existing plants.

Advantages compared to current solutions:

- A photovoltaic system can cover 20-40% of the electricity demand in self-consumption; in combination with battery storage, this degree of self-sufficiency can be increased to over 80%.
- The combination of the photovoltaic (PV) system, battery storage and charging infrastructure offers several advantages in terms of power utilisation and control options: self-use of electricity, control options: enabling intelligent control of the energy flow, independence from the electricity grid as well as environmental friendliness: The use of PV electricity and storage in the battery reduces the need for electricity from fossil sources and thus contributes to the reduction of CO2 emissions.



Total solar roof solution for the built environment offers clean electricity generation and attractive return on investment

Summary:

A Danish company has developed a new patented solar roof technology for the built environment. The solar roof technology is already tested and applied across 450 installations in Denmark and Germany. The Danish company offers commercial agreement to interested partners such as housing associations, commercial buildings, utility companies and municipalities.

Advantages compared to current solutions:

- Cost reduction: 100% compared to traditional roofing materials;
- Performance increase: 50% compared to traditional on roof systems.

Other advantages:

- Complete roofing solution incl. flashings, etc.;
- Attractive Return on Investment with high Internal Rate of Return (IRR);
- No fire hazard as opposed to traditional PV systems;
- SMART system integration with batteries and smart meters;
- Available in 2 colour options, Black and Tile Red.



Contact: Jesper Vestergaard Hansen, jvh@southdenmark.be

Custom integrated solar facade systems with positive Return-on-Investment (ROI)

Summary:

Custom solar facade solutions for new build & retrofit. Full architectural design freedom, including colors and finish to panel shape. These high-quality cladding systems are designed for the circular economy, and provide a resilient, low-maintenance and low risk path to net-zero.

Advantages compared to current solutions:

These custom cladding systems integrate solar power directly into the building façade, utilising all available area of the urban building for energy production. With a multi-generational lifespan, they provide a beautiful architectural demonstration of the building's environmental commitments and contribution.

- Performance increase (%): 100%, compared to conventional, non-PV façade cladding materials;
- Return-on-Investment (%): Positive ROI over façade lifespan.

Other advantages:

- Light weight;
- Low maintenance;
- Unparalleled design freedom;
- Cost-effective and sustainable;
- Positive ROI;
- Freeing-up of roof space for other uses.



Contact: Jesper Vestergaard Hansen, jvh@southdenmark.be

Methane generating reactor waste-to-energy and wastewater treatment technology

Summary:

An Australasian company with an office in Italy has 20 years of experience in designing and building biogas and biomethane plants with waste-to-energy and wastewater treatment technologies. The company has developed new efficient, sustainable and economically viable solutions applicable to the waste-to-energy and wastewater treatment value chain.

Advantages compared to current solutions:

- The in-ground digester results in a cost reduction of 33% over conventional CSTR systems.



Additional information:

<https://een.ec.europa.eu/b2b/profile/74221a1f-fda1-4539-bb24-018335cde7af>

Contact: Marco GORINI, marco.gorini@venetoinnovazione.it

Other advantages:

- A highly engineered in-ground anaerobic digester with the ability to receive very high strength and very high volumes of industrial waste and wastewater;
- The high-volume digester allows long retention times that permit secondary breakdown of residual organic compounds;
- Other innovations include the premixing of anaerobic sludge with incoming waste and the sequential automated distribution of organic load throughout the digester sludge blanket;
- Very low operating and maintenance costs;
- Highly resilient against shock hydraulic and organic loadings;
- Pesticides have been proven to be completely decomposed with the digester;
- Aromatic hydrocarbons, aromatic alcohols, and polyester type hazardous liquid wastes are received and digested by the CGR.

Low cost high performance solar thermal device

Summary:

A Spanish project has developed a new solar thermal device which uses solar energy to supply manageable heat (150 oC - 400 oC) to industrial processes. It consists of a rotatory solar collector, and a thermal storage system, both integrated and connected to the industrial process. Its special features include; modularity, compactness and low cost, means it is suitable for many applications. In addition, an enhanced version of the solution is able to supply high quality solar energy at high latitudes where other solutions fail.

Advantages compared to current solutions:

- Around 650 €/kW;
- Levelized cost of manageable heat: 50 €/MWh.

Other advantages:

- Compactness;
- Modularity;
- Large reduction in the materials needed: 30% in glass, 30% in steel, 70% in concrete;
- High performance even at high latitude (higher than 45o N) where other solar concentration technologies fail.



Contact: Mercedes Lecea, mercedes.lecea@madrimasd.org

Portable solar power: plug & play deployable structure for emergency situations where there is no access to the grid

Summary:

Spanish company has developed a system of deployable solar panel structures, based on aerospace technology. Easy to use, and no prior installation or maintenance required, makes this an ideal energy production solution for emergency situations, such as natural disasters, and in rural areas, where existing energy grids are not working or present. The structure can be placed where fixed solar energy systems can't. It is a portable solar power station, being assembled and disassembled in less than 5min.

Advantages compared to current solutions:

- Cost reduction: 40/50%;
- In less than 5 minutes of installation it becomes a working photovoltaic station providing energy in crisis situations or at places with lack of grid;
- Greater performance: according to solar hours;
- Available on the market, demonstrations possible.

Other advantages:

- Portable solar system that is easy to transport and assemble;
- Possibility to connect to the electrical network;
- Does not require maintenance, plug and play;
- Reduce carbon footprint.

Contact: Mercedes Lecea, mercedes.lecea@madrimasd.org



Pontoon hydrokinetic power plants on slow river courses boosted by gravity

Summary:

A Bulgarian innovative company has developed a hybrid paddle wheel that uses gravity to boost rotation with fixed radial overwater cantilevers ending in elongated movable paddles cantilevered on simple hinge mechanisms. The mechanism maintains the paddles, instead of radially, always in vertical positions above and below the water. Possible partners are hydro power companies, utilities, water management consortia and local communities and municipalities.

Advantages compared to current solutions:

- The blades are immersed at about 45% of the wheel radius, instead of 12% for the familiar water wheels, which allows them to work in a 3.5 times deeper water layer, which increases their efficiency to about 45%;
- The overall efficiency of electricity production is about 40% - about 3 times cheaper than 5 MW wind turbines and 4 times cheaper than photovoltaic parks;
- The paddles enter the water vertically downwards with their narrowest side and therefore the drag in the water is minimal;
- The shaft of the hybrid wheel and all components of the pontoon hydroelectric power plant are above the water;
- The revolutions of the hybrid wheels many times higher than those of known water wheels at the same load in comparable water conditions.



Contact: Svetoslava PAVLOVA, een@chambersz.com

Storage

Electricity Storage

Thermal Energy Storage

Container based green energy production and storage system for stabilizing voltage supplies



Summary:

A Hungarian innovative company is offering a system that is suitable for generating electricity day and night by utilising both wind and solar energy. The solution comprises three different technologies that complement each other: “black” solar panels, vertical axis wind generator, and a specially designed lithium-battery pack with battery management system (BMS). The developer company is looking for potential partners interested in distribution and commercial partnerships.

Advantages compared to current solutions:

- Payback period: 5 years;
- Extremely long lifetime of battery pack due to BMS: min. 30 years.

Other advantages:

- It can be transported anytime, installed anywhere and rented or leased;
- Adaptable directly for green energy storage (wind, sun, water, steam);
- Small size and high performance;
- Can store high volume of energy from power plants (water, steam, gas);
- It can be transported anytime, installed anywhere and rented or leased;
- Adaptable directly for green energy storage (wind, sun, water, steam);
- Small size and high performance;
- Can store high volume of energy from power plants (water, steam, gas).

Additional information: <https://een.ec.europa.eu/b2b/details/d39ab727-68d8-4bce-af9a-0182a6afbf45>

Contact: Dr. András Kiss, kiss.andras@hbkik.hu



Energy storage solutions for the decarbonisation of industrial processes through thermal energy storage and management of renewable energies in a thermal battery



Summary:

A Spanish start-up focuses on the decarbonisation of industrial processes using heat. The technology is based on a thermal energy storage battery which allows the generation of heat from renewable energy sources when energy prices are low, to store it and dispatch it when needed, being able to feed industrial processes up to 250-300°C. The compact design of high energy density capacity helps to replace fossil fuels, ensures energy supply, reducing costs as well as carbon footprint.

Advantages compared to current solutions:

- 5 to 15% reduction in Scope 1 carbon footprint;
- Lower cost (<100€/kWh) when compared with electrochemical batteries, with a technological price around 60 €/kWh but a market price, for the whole installation, around 300€/kWh;
- Higher equipment lifespan (in the range of 20 years) when compared with electrochemical batteries (5-10 years);
- More mature technology when compared with other potential solutions such as hydrogen;
- It doesn't require the use of scarce chemical elements (i.e. Lithium);
- It is a more cost-effective solution to provide heat supply than storing power for heat applications, since theoretical efficiencies of electricity-to-thermal energy storage-to-heat are in the range of 97% (around 50% of global energy demand in form of heat).



Additional information: The company has received several grants, including Next Generation EU fundings, as well as funding from regional government of Navarra.

Contact: Idoia Franco Juarros, ifranco@ain.es

Battery energy storage systems reduce energy costs by 30%

Summary:

Spanish company develops and implements technological solutions to give li-ion batteries a second life. At the end of their lifespan in an electric vehicle, batteries maintain a large storage capacity (70%-80%) and still offer high performance, thus, are perfectly functional for other uses such as:

- Medium and large-scale energy storage (80kWh-4MWh) for industrial systems and network optimisation;
- Small-scale energy storage (6kWh-12kWh) for self-consumption in public and private buildings.

Advantages compared to current solutions:

- Sustainability: Reduction of CO2 emissions and greater energy efficiency;
- Cost reduction: 30% reduction of energy costs;
- Payback: 5-6 years;
- Integration with any type of energy source. Monitoring of the full installation and optimisation of energy costs;
- Own Energy Management System, allowing the monitoring and control of the full installation, with or without photovoltaic production;
- Standardised industrial process to characterise battery modules and battery packs for electric vehicles.



Solid-state hydrogen storage and cost-saving, optimised energy management software

Summary:

A London-based company has developed hydrogen storage hardware and software solutions. The hardware uses solid-state technology for medium to low-pressure applications; it is being tested at a MW scale in the field and pre-orders are available. The software optimises the design and real-time control of green hydrogen systems. This includes optimal sizing and operation of all assets in a system. It has been tested and is ready for use in heating, blending, and transportation applications.

Advantages compared to current solutions:

- OPEX cost reduction with software: over 25%;
- Reduction in £ / kg hydrogen stored with hardware: 50%.

Other advantages:

- Hardware releases hydrogen 2-3x faster than the current state of the art;
- Offer both hardware and software products;
- 8 years of experience in working with hydrogen;
- Appropriate for commercial scale.

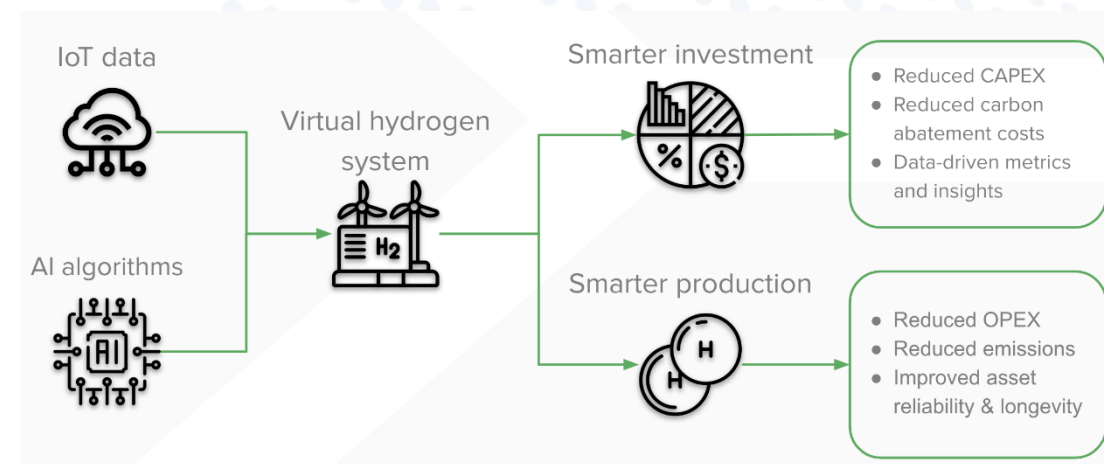

Contact: Nghia Tran, nghia.tran@innovateukedge.ukri.org

Unleash the Renewable Energy potential, introducing a green hydrogen storage system

Summary:

An Italian innovative start-up founded in 2021, located in Genoa, focuses on unleashing the Renewable Energy potential, by means of a green hydrogen storage system.

The company deals with the design and technical development of systems, materials, and plants for hydrogen storage using materials to store this energy carrier even in the solid state, in hydrides of various kind.

Advantages compared to current solutions:

The main product is an energy storage system, in the form of hydrogen, based on hydrides; this way the energy carrier H₂ is accumulated in solid state. The solid-state storage represents an innovative solution, as it allows increasing the volumetric energy density, using special storage systems with high technological value, because they allow decreasing the operating pressure of the system, the associated risks, and the overall energy consumption of the storage step.

Other advantages:

- Safety;
- Low pressure;
- High density storage;
- Recyclable.

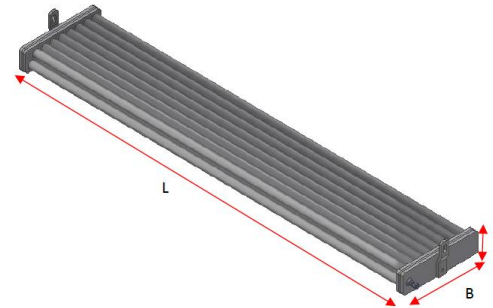

Storage capacity	H ₂ capacity (nominal)	kg	0,6
	Energy stored	kWh _{th}	20
Charge	Pressure	bar	20-35
	Temperature/Temperatur	°C	15-25
	H ₂ Flow max	kg/h	0,4
	Thermal Power required	kW _{th}	1,5
Discharge	Pressure	bar	1.5 - 30
	Temperature	°C	40
	H ₂ Flow	kg/h	0,4
	Thermal Power required	kW _{th}	1,5
Dimensions	(L x B x H) - mm		1500 x 295 x 75
Weight	kg		75
External temperature	°C		-20 to 50

Additional information: Founded at the end of 2021 the start-up has yet a tested product ready to the market.

Contact: Raffaella BRUZZONE, raffaella.bruzzone@ge.camcom.it

Making the energy transition faster and more economically attractive with intelligent energy storage systems

Summary:

The German company is a developer, project planner and operator of energy management and storage systems and offers almost unlimited scalable storage solutions from 0.5 MWh. The entire chain from project planning to economically optimised operation and marketing of their performance is covered from a single source. The portfolio is aimed at users from the renewable energy environment, the energy sector, industry or clean-tech investors.

Advantages compared to current solutions:

- Scalable & flexible storage solutions;
- In-house developed intelligent energy management system (iEMS);
- Short implementation periods;
- Long usability & service life;
- Large-scale storage for industry & commercial;
- Grid storage for renewable energies;
- Multi use-cases, frequency control reserve & trading;
- High standards and certifications (IEC-standards, ISO9001);
- Battery system competence - in-house.



Contact: Sonja Angloher-Reichelt, angloher@bayern-innovativ.de

Belgian SME giving a second life to used batteries from electric vehicles is looking for partners to explore opportunities in the second-life battery value chain



Summary:

Belgian company in second-life stationary energy storage has developed proprietary software for advanced battery analytics for second-life battery energy storage systems to predict degradation while in operation. The innovation consists of a second-life battery energy storage system equipped with an 'integrated battery & energy management system' (iBEMS). It is particularly useful for second-life battery storage.

Advantages compared to current solutions:

The innovative energy storage system houses used batteries from electric vehicles. These batteries have a remaining energy storage capacity of 80% or more left. Stationary energy storage has lower requirements on charging power, better controlled temperatures and weight % space. Batteries can last to 10 years in this system.

The company is looking for partners in the battery value chain to supply dismantled and tested automotive batteries to execute the repurposing of the batteries into a stationary energy storage systems. Their service optimises the charging of the battery for a range of different use cases such as self-consumption, peak-shaving and grid services, increasing the customers' return on investment. The company has sold 5 MWh of battery storage capacity in the past year and delivered 1MWh.

Other advantages:

This technology gives improvements on monitoring, optimal control, extended lifetime, and predictive maintenance.

Additional information: <https://een.ec.europa.eu/b2b/profile/12046b48-b3e4-4f3d-9a05-018070a57cd6>

Contact: Sabrina Bijlsma, sbijlsma@hub.brussels





Mobility / Electric Vehicles

Solution related to Clean Mobility

Solutions for Electric Vehicles

Dual-fuel technology that enables existing large diesel engines to run on a mixture of diesel fuel and alternative greener fuels i.e. Bio-LPG, or Hydrogen

Summary:

UK company has innovative dual-fuel system technology that permits diesel engines to adopt cheaper, cleaner, and renewable fuels. Their technology is proven within the UK and US for freight and passenger rail, maritime, and trucks, as well as in small scale power generation. Dual-fuel technology extends the life of existing transport vehicles and at the same time addresses cost and carbon emissions by enabling adoption of alternative cleaner fuels.

Advantages compared to current solutions:

- Cost reduction: 20+%;
- Emissions Reduction: Up to 90%;
- Return-on-Investment: As little as 6-18 months dependent on application.

Other advantages:

- The dual-fuel system ensures no difference in the performance or response of the engine;
- The engine can be optimised for power, economy, or emissions;
- The original safety systems within the engine will not be compromised;
- Dual fuel remains one of the few solutions to de-carbonise heavy duty diesels;
- The leading dual fuel company in the UK and expanding partnerships across Europe.



Innovative platform for sustainable mobility around Mont Blanc area (suitable for areas with intensive tourist populations)



Summary:

An integrated technological solution to meet the sustainable mobility needs of tourists and citizens and to give visibility to sustainable mobility services/operators. It also enhances sites of cultural interest through virtual tours and supports decision-makers in monitoring the solution and planning decisions. It encompasses a green car sharing solution able to combine stay in accommodation facilities with the use of electric cars to move around the Espace Mont Blanc.

Advantages compared to current solutions:

- Increased use of sustainable vehicles;
- Reduction of own car use;
- Reduction of pollution caused by emissions from road traffic;
- Visibility of green mobility companies/services;
- Integration of mobility data.



Contact: Federico Molino, f.molino@pie.camcom.it

Ecological conversion of conventional cars into hybrid solar vehicles

Summary:

A group of Italian companies has developed some prototypes almost ready for industrialization (TRL 8/9), transforming conventional motor cars (Diesel, gasoline) into hybrid solar, by adding electric wheel motors in back wheels, a battery, and flexible solar panels. The system is patented in several countries. It allows the re-use of cars often in good conditions, reducing fuel consumption and emissions, both during their use and, further, within a LCA perspective.

Advantages compared to current solutions:

- Cost reduction with respect to Hybrid Vehicle or Electric Vehicle: 20-40 %;
- Performance increase: 10 %.

Other advantages:

- Vs Conventional vehicle: Reduction in consumption and emissions (up to 20% in typical urban use);
- Vs Electric Vehicle: lower cost. No problems of limited range and recharging time. CO2 reduction due to lower consumption related to hybridization and green solar power;
- Vs Hybrid vehicle: lower cost. Partial solar recharge of battery. More sustainable;
- Fuel consumption and emission reduction: up to 20% in urban driving.



Additional information: <https://een.ec.europa.eu/b2b/profile/d2785274-7e0b-4546-a9b9-018798fc1f7b>

Contact: SabMartina CALIANO, martina.caliano@enea.it

Belgian engineering company offering fuel-optimising technology is looking for technical cooperation

Summary:

Belgian SME has developed a fuel-optimising technology that helps conventional & biofuel users to achieve their environmental goals faster through fuel savings and emission reductions within their current infrastructures. The innovative solution consists of ethanol and ionic compounds produced by a patented process. The solution is tested in different continents and certified by third parties and ASTM, which means the treated fuel remains standard fuel and is engine friendly.

Advantages compared to current solutions:

The solution changes the interaction of the hydrocarbon molecules with the Oxygen molecules and other oxidants during the combustion. The solution can be blended with liquid fuels at a refinery, central fuelling tank, or point of use and instantaneously creates a efficient low-carbon fuel. As a result, lower harmful emissions will be produced for the same fuel volume, helping end users meet their net-zero goals faster.

- Average 60% reduction in NOx emissions;
- Average 10% reduction in CO emissions;
- Average 70% reduction in smoke and emissions particles;
- Average 42% reduction in CH4;
- Average 29% reduction in THC emissions.

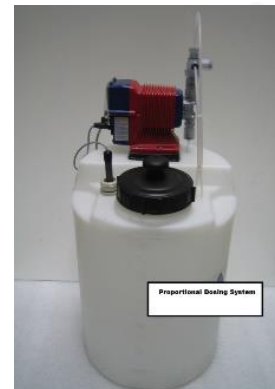

Other advantages: The technology can be used in centralised, non-centralised tanks and storage systems. Fuel consumption and emission reduction: up to 20% in urban driving.

Additional information: <https://een.ec.europa.eu/b2b/profile/9d08bde2-03d1-4f6f-883b-0187288f2477>

Contact: Sabrina Bijlsma, sbijlsma@hub.brussels

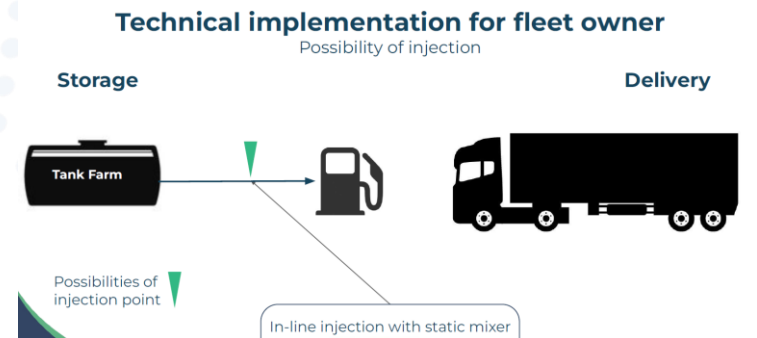
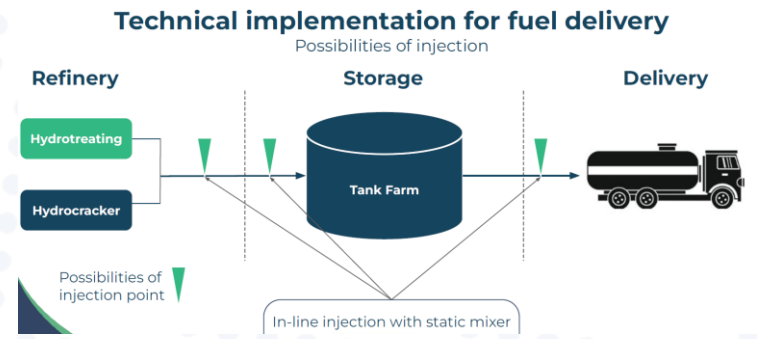

Intelligent charging for e-mobility in residential blocks using solar and blockchain technology

Summary:

A German company has digitised the distribution of renewable energy on the blockchain. One application is for e-mobility charging in underground car parks in residential buildings by using self-generated solar energy. The energy management system organises energy distribution to the charging infrastructure and the energy consumption of the building by matching with the solar generation. Investments in grid expansion is not needed, and saved CO2 can be traded via certificates on the ledger.

Advantages compared to current solutions:

- Cost reduction: 40%;
- Saving of carbon dioxide: 70%.

Other advantages:

- Decentralisation of renewable energy for e-mobility and buildings (sector coupling);
- Participation of EV drivers and residents for the energy and mobility transition;
- New business opportunities for residential real estate by saving carbon dioxide and trading on the CO2 emission exchange starting in 2026;
- Scalable system which can include other applications in a smart city (e.g. heat pumps);
- Tariff roaming for public EV charging;
- Machine Learning / AI.



Contact: Simon Horoz, horoz@img-rlp.de

High-performing and innovative natural additive for liquid hydrocarbon fuels to decrease fuel consumption and reduce the emissions in exhaust gases



Summary:

Bulgarian company invented a natural enzyme additive suitable for all liquid fuels, which delivers bound atomic oxygen, which is actively involved in the combustion process. These are synthesis products from cells of living organisms in nature which catalyse, break down, move and assemble various molecules into biochemical groups and thus create new biological compounds. They offer commercial agreements to interested partners as transport sector and logistic companies, agricultural, construction, etc.

Advantages compared to current solutions:

- Cost reduction: Noticeable economic savings of at least 10% of the fuel input.

Other advantages:

- The improved combustion of the engine power increases in parallel with its detonation resistance;
- The cold start and engine ignition are improved, soot deposition in the DPF filter is reduced;
- Prevents the formation of tar deposits on the EGR valve, thus increasing its life span;
- Reduction of unburned hydrocarbon emissions in exhaust gases by 83 %, thus significantly reducing their toxicity and hence air pollution;
- The level of measured toxic carbon monoxides is reduced by 33 %, nitrogen oxides reduced by 17 % and fine particulate matter reduced by 15%.



Contact: Svetoslava PAVLOVA, een@chambersz.com

Energy Efficiency for Buildings & Industrial Buildings

Improving energy efficiency in buildings e.g. monitoring, behavior or intelligence

Improving energy efficiency in industrial buildings

A Swiss company has developed a highly efficient heat exchanger technology that recycles up to 50% of the otherwise wasted heat energy from wastewater



Summary:

This linear and double walled safety heat exchanger is fully integrated in linear drains or shower trays and can be installed in private showers as in public wet rooms. The scalable technology is drinking water certified by European institutions and combines aspects like high efficiency, easy to install and clean and a nice design.

Advantages compared to current solutions:

- best in class efficiency, up to 50% savings;
- payback time in public buildings after 0.5 year;
- payback time in domestic buildings between 3-5 years;
- double walled construction of the heat exchanger incl. an acoustic leakage alert;
- drinking water certified (KIWA, DVGW, SVGW, WRAS);
- easy to install and easy to clean;
- replaceable heat exchanger without any special tools needed;
- scalable technology up to OEMs needs;
- already 10'000+ installations in Switzerland and the Netherlands.

Other advantages: fewer peak loads thanks to drain water heat recycling.

Contact: Ernst-Jan van Hattum, ernst-jan.vanhattum@innosuisse.ch

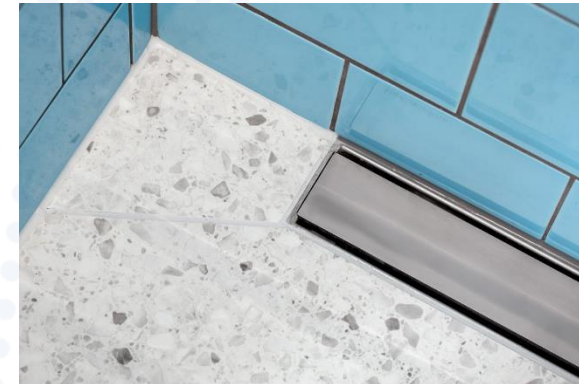

Automated energy management system (EMS) with Open Source ISO 50001 Systems and on-demand consulting services



Summary:

An Italian innovative SME designs, develops, installs, maintains and supports Open Source ISO 50001 Energy Management Systems (Hardware & Software) for the industrial and tertiary sectors. The technology supports; Regulatory Compliance (Energy Audits and ISO 50001 Certification), Cost Engineering (Real-time energy cost per unit), Reduced Energy Consumption (Improve margins on products and services), Reduced Waste (management of surplus energy).

Advantages compared to current solutions:

- Cost reduction: minimum 20%;
- Performance increase: minimum 20%.

Other advantages:

- The software is Open Source which supports continuous product / service improvement.
- The solution is highly configurable to support 'Custom Fit' so that the specific requirements of each customer location, energy supply, and interoperable systems, can be met.
- The system works with real-time information which is efficient and effective.
- The system offers an Energy Manager 4.0 platform and is EGE (Expert in Energy Management) certified with on-demand services provided remotely.



Contact: Federico Molino, f.molino@pie.camcom.it

Save 15-40% energy in the building installation through data driven building control

Summary:

A Dutch company offers a multi-user software platform for data driven building control. The platform creates a real-time digital twin of the buildings HVAC (heating, ventilation and air conditioning) systems, collects high frequency data and uses the information to automatically calibrate and improve building controls. The solution is flexible and can be added-on to existing BMS (building management systems) and saves between 15-40% energy, with relatively low start-up costs and fast return on investment.

Advantages compared to current solutions:

- Cost Reduction: Savings of between 15% and 40% cost of energy reduction;
- Return on Investment: Between 1-2 years (subject to local energy prices).

Other advantages:

- Easy to use interface for building owners to better control their HVAC installations;
- Building owners have data and insights of the building's HVAC and energy performance;
- Automatic controls add to efficiency of the installation, resulting in savings between 15 and 40%;
- With the high current energy prices, the return on investment is often only between 1-2 years.



Contact: Jannes Kalfsbeek, j.kalfsbeek@newenergycoalition.org

AI-driven automated energy management system to achieve revenue generation from flexibility markets



Summary:

UK company with energy automation technology designed for commercial offices, schools, leisure centres, hotels, and small industrial sites. The platform is AI-driven and connects locally to any existing building management system (BMS). The AI-driven system makes real-time energy management decisions based on data calculations from; energy use, energy cost, grid carbon intensity, and grid flexibility demands. The result is automated onsite control to reduce carbon, costs and generate revenue from grid flexibility markets.

Advantages compared to current solutions:

- Cost reduction: 10-20+%;
- Return-on-Investment: up to 100% (based on revenue generation from energy flexibility markets).

Other advantages:

- Reduce energy use & cost through optimisation, efficiencies, flexibility;
- Generate new revenues by providing flexibility for local energy networks;
- Enables investment planning for renewable technologies based on real energy data modelling;
- Assess the ROI on future investment in green generation & storage;
- Minimise risk of exceeding maximum capacity allowance by automating energy demand profile;
- Experience of deployment at municipal projects.



Contact: James Snelgrove James.Snelgrove@innovateukedge.ukri.org

Unique, free, energy efficiency solution for buildings, reducing energy used for heating by 30%



Summary:

A Danish green-tech company has developed and patented a unique energy efficiency solution, that saves 30% on energy used for heating in public buildings and private offices. The business model is risk free, meaning that the company install and run the solution without cost, in return for a share of the cost savings achieved. The solution is commercially available today, with new features including a similar predictive feature for optimising energy used for cooling.

Advantages compared to current solutions:

Cost Reduction: 20%

Performance Increase: 30% (lower energy consumption compared to normal installation)

- No initial investment required, and a risk-free business model;
- Sensors are easy to clamp-on existing cables, pipes, etc., without breaking into the installations, and can be installed by non-technicians;
- AI based automated analysis and optimization;
- The cloud-AI and sensors work as one; over robust data-connections;
- Maintenance-free: Alarms are self-learning, and battery-replacement avoided as the sensors have 15 years of battery life.

Contact: Jesper Vestergaard Hansen, jvh@southdenmark.be



Tap water solution product that saves 50% of your hot water energy consumption

Summary:

A Swedish company has developed a product that provides instant hot tap water. The product works by drawing water out of the pipe when a tap is turned off, returning it to the tank or heat exchanger, leaving an empty pipe. The instant a tap is opened, water is delivered directly to the tap. This happens so quickly that the effect is instant hot or cold water.

Advantages compared to current solutions:

- Saves 50% of your hot water energy consumption;
- The pipes will be empty 99% of the time;
- The product provides Instant hot water, you never need to waste 50 % of your hot water by waiting for the hot water to arrive to the taps from where the hot water gets heated. Or you don't get any hot water wasted by letting it cool down in the pipes between where it get heated and where it is tapped out for usage.

Other advantages:

- The pipes do not have to be insulated, so the pipes take up very little space in the shaft;
- An empty pipe can neither freeze or leak;
- Minimize the risk of legionella disease.

Contact: Lars-Ake Isaksson, lars-ake.isaksson@ltubusiness.se

Digital heating management solution for non-residential buildings saves up to 32% heating costs

Summary:

A German company helps companies and municipalities to save up to 32% of heating energy and CO2 emissions in their non-residential buildings by installing self-learning radiator thermostats and using an online platform which enables efficient heat consumption monitoring in real time. While the thermostats control the room temperatures are fully automated and demand-based, the connected web portal allows for a central and efficient management of the property portfolio.

Advantages compared to current solutions:

- Savings of up to 32% heating costs & CO2 emissions;
- Helps solve the free-rider-problem (people do not turn down conventional thermostats if they are not personally paying the heating costs);
- Low-hanging fruit that allows for quick wins in terms of substantial energy savings.



Other advantages:

- Intelligent self-learning system;
- Demand-based & fully automated individual room control;
- Low-investment measure with short payback period (1-5 years);
- Thanks to wireless radio transmission, retrofittable without structural measures;
- Also available with vandalism protection on request, particularly useful in public buildings and educational institutions.



Contact: Lothar HARTMANN, hartmann@tutech.de

Intelligent indoor air management solution that adapts the building's ventilation to the actual measured data

Summary:

The Finnish company with a long history in the industry has developed a unique solution for air quality management - the simplest and fastest energy efficiency renovation that adapts to virtually any existing air ventilation system. The solution uses smart algorithms to adapt ventilation according to measurement data collected by internal sensors, providing a healthy indoor climate, reduced carbon footprint, and savings up to 55 % in electricity and 19 % in heat.

Advantages compared to current solutions:

Building's air ventilation based on measured data and not on clock-based programming.

- MEASURING: CO₂, TVOC, T, RH, P, Nox;
- OPTIMISING: Learning algorithms;
- CLOUD PLATFORM: Two-way data transfer;
- OPEN CONNECTIVITY: ModBus, RestApi;
- Return on investment: 12 - 18 months;
- Saves heating energy: 8 - 17%;
- Saves cooling energy: 20 - 39%.

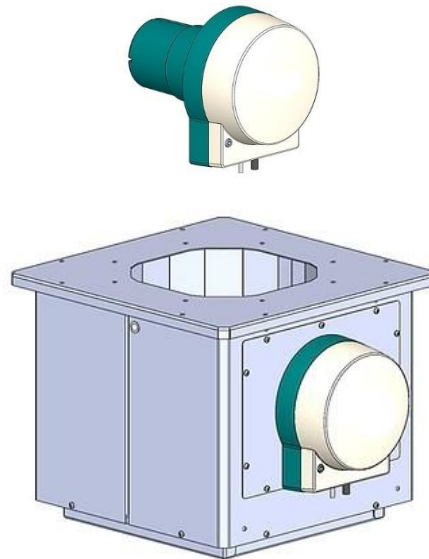

Other advantages:

- The company's solution is easy to install even to older buildings and connect seamlessly to third party systems through open data interfaces.



Additional information: <https://een.ec.europa.eu/b2b/profile/20696558-e4a0-4d2b-8053-018017dfba17>

Contact: Mari Kivinen, mari.kivinen@turkubusinessregion.com

Cost effective energy saving air curtains that create an invisible door that keeps heat or cold inside buildings

Summary:

A Dutch company has developed circular and cost-effective air curtains that create an invisible door at entrances of buildings or spaces. With its precisely adjusted air velocity and capacity, they give protection throughout the opening and provide the most efficient separation with the lowest possible energy consumption, regardless of whether it is the heat or the cold that you want to keep inside. Commercial agreement is offered to retail, industry, utility companies and municipalities.

Advantages compared to current solutions:

Based on a standard door with electric heat exchanger:

- Cost reduction: between 60-80%;
- Performance increase: 50-80%;
- Cost/watt EUR/watt): electricity +/- €0,25;
- Return-on-investment: 2 year.

Other advantages:

- easy to install;
- customer friendly;
- BMS (Building management System) or weather controlling (more savings).

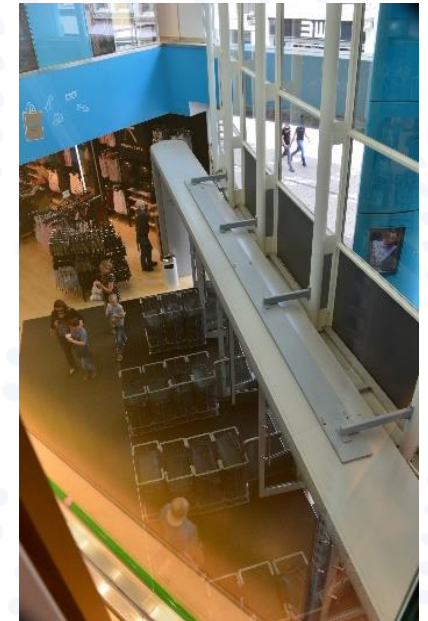

Contact: Nils Haarman, nils.haarman@rvo.nl

Air-to-air VRF (Variable Refrigerant Flow) heat pump system for heating and cooling large spaces

Summary:

A Dutch climate control specialist offers a Variable Refrigerant Flow (VRF) system, which is specially developed for energy-efficient heating and cooling of large spaces (garages, warehouses, production facilities, etc.). The combination of an air-to-air heat pump (outdoor unit) with a compact air heater / cooler (indoor unit) ensures excellent performance. Thanks to the extensive setting options, the installation can be fully adapted to the use of the building and the wishes of the users.

Advantages compared to current solutions:

- Heating: Nominal capacity: 37.5 KW. Power consumption: 9.08 KW. Seasonal Coefficient of Performance (SCOP): 4.05;
- Cooling: Nominal capacity: 33.5 KW. Power consumption: 15.3 KW. Energy Efficiency Ratio (EER) : 2.19.

Other advantages:

- Available with powers of 33 kW and 56 kW;
- Air to air heat pump VRF-system;
- Cooling and heating. Cooling: +17°C – +43°C and Heating: +7°C – +25°C;
- Large temperature range;
- Optional: integrated condensate pump.



Contact: Nils Haarman, nils.haarman@rvo.nl

Building energy management system - solution for smart control and energy monitoring

Summary:

The proposed solution is part of the innovative Italian company's suite conceived to homogenise and rationalise the different solutions included in the company's portfolio of green tech solutions. The BEMS (Building Energy Management System) conceived is a modular and multi-context solution, providing support to operators in different areas: for monitoring consumption, for cost analysis and timely verification of billing and for the automation of technological systems, with advanced centralised coordination functions.

Advantages compared to current solutions:

The platform's flexibility, versatility and scalability allows to:

- Not to be invasive but complementary, compared to the technologies already installed;
- communicate directly with the field equipment, making its complexity transparent;
- integrate heterogeneous technologies (current and future);
- create proper customisations according to specific monitoring and analytical requirements;
- be open to future evolutions of the supervision and remote-control scenario (new subsystems).

Given these features, BEMS application platform allows companies to have an energy cost reduction near to 10% and a ROI between 6-12 months. BEMS is usually customised in the vertical application context, in which it is intended to be integrated for monitoring and remote control.

Contact: Raffaella BRUZZONE, raffaella.bruzzone@ge.camcom.it

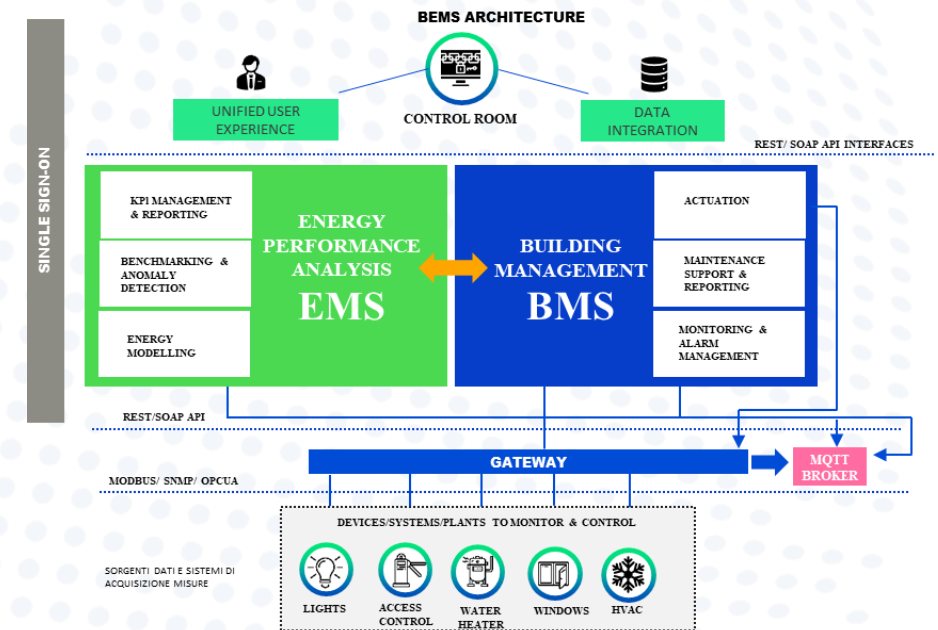

Belgian digitalisation company offers their services to enable the sustainable digital transition of the Architecture, Engineering & Construction (AEC) industry



Summary:

This innovation is a sustainability-based service optimising the costs & planning of building projects through digitalisation, leading to better management and increased vision of territorial developments in larger infrastructure works. Services are based on versatile civil engineering studies to ensure a more sustainable urban planning and optimisation of production for manufacturers. Services in sustainable digitalization, focusing on BIM, smart building, smart cities, digital twin, and other related areas are offered.

Advantages compared to current solutions:

- Energy savings up to 50% in commercial buildings can be achieved;
- Using BIM can lead to energy savings of up to 30% in the design and construction phases of a building project;
- Integrating sustainability into BIM can lead to energy savings of up to 20% in building operation and maintenance;
- Using BIM to optimise building design can lead to a 20-30% reduction in energy consumption and a 50-70% reduction in carbon emissions over the lifetime of a building;
- Using BIM and sustainable design strategies results in energy savings up to 40% in commercial buildings.



Other advantages:

- Compared to mainstream BIM services, this BIM solution offers a service, sustainability-based, optimising the costs and planning of building projects through digitalisation, leading to better management and increased vision of territorial developments in larger infrastructure works.
- Clients are e.g. Municipality, Real estate developer, construction company, architecture office, engineering firms.

Additional information: <https://een.ec.europa.eu/b2b/profile/a3861504-411a-42e0-aeb4-018713bef710>

Contact: Sabrina Bijlsma, sbijlsma@hub.brussels

Remote Monitoring Solutions for energy, water and other parameters



Summary:

Bulgarian company offers remote monitoring solutions with underlying IoT infrastructure bundled with a functional back-end platform and industry applications that allow businesses to monitor their consumption of electricity, water, pressure, temperature, and other parameters depending on the needs. The company produces proprietary data loggers that support a variety of end devices tested thus providing end-to-end solutions to customers within commercial agreement with technical assistance.

Advantages compared to current solutions:

Cost reduction: Depending on the use case 15-30 % optimization of energy/water consumption.

Other advantages:

The proprietary mobile data loggers include low power models, and a broad number of connectivity options including GPRS, 4G, LoRa Wan, NB IoT and CAT-M1. In a broader perspective, the company brings a mix of expertise from all layers of the IoT technology starting from the hardware and firmware, back-end platform, front end applications and in-depth industry knowledge in energy and water monitoring that enable businesses and utilities to optimise consumption and reduce costs, while ensuring a safe and secure operational environment.



Contact: Svetoslava PAVLOVA, een@chambersz.com

Environmentally friendly, patented system for treating water against limescale without chemicals, electricity or magnets, leads to energy-saving benefits

Summary:

A German SME offers a patented and German-made water treatment system to install on the incoming mains of properties and buildings or before boilers and appliances to protect against hard limescale and corrosion in pipes and on heating elements. Applications are for homes, commercial buildings, hospitals and industry. It does not soften the water nor does it take out the minerals but neutralizes the aggressive limescale, protecting metal surfaces, ensuring a better performance and contributing to better energy efficiency in boilers and heating systems.

Advantages compared to current solutions:

- Cost Reduction: Savings of between 10% and 25% cost of energy reduction.



Other advantages:

- Prevents the formation of new limescale and slightly decreases existing limescale by the process of erosion with the water flow;
- Quality Made in Germany;
- No external electricity necessary;
- No minimum flow needed;
- No chemicals needed;
- No salt needed;
- No maintenance needed;
- Patented in all important markets.

Additional information: <https://een.ec.europa.eu/b2b/profile/308c3fce-ac1e-4547-80ab-01815d832425>

Contact: Sabrina Wodrich, sw@zenit.de

Energy Efficiency for Cities & Communities

Improving energy efficiency in cities & communities e.g. with smart systems in public spaces

Portuguese SME offers smart management systems to support renewable energy communities to maximize the value of local energy markets.



Summary:

A Portuguese company removes friction and complexity from local energy markets, helping to create, build, manage, and expand local Renewable Energy Communities (REC). It offers Smart systems for Energy Communities to maximise energy cost reduction in local energy markets.

The solution provided by this SME enables prosumers to participate in advanced demand response programmes that dynamically match and optimise local generation with local consumption, based on flexibility.

Advantages compared to current solutions:

- Cost reduction: up to 40%;
- Highly scalable, integrated, flexible and secure platform adapted to different regulatory frameworks;
- Holistic management of all aspects of REC;
- Promoting the creation of viable REC as well as local energy markets;
- Aggregation of small and medium energy assets and loads, including batteries, electric vehicles (EV) chargers, heaters, boilers, chiller, etc.;
- Cost/Watt (EUR/Watt): No initial costs.

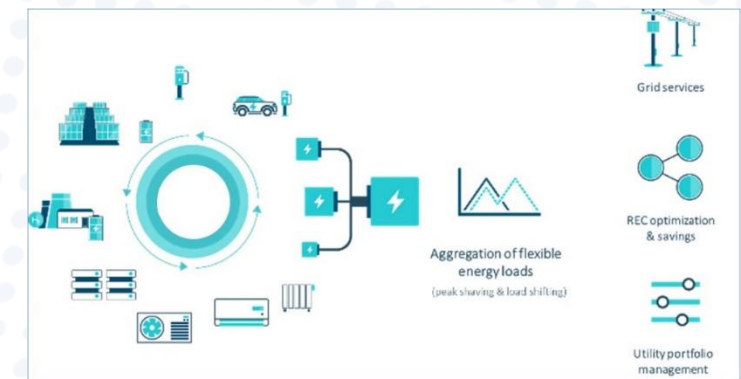

Contact: António Couto, antonio.couto@lneg.pt

Digital system helps with sustainable energy management for factories, industrial centres, offices, retail chains, and public administrative buildings



Summary:

Slovak company has developed a solution that combines advanced energy cost management with respect for the environment. The solution measures and collects energy and emission data online. The obtained data are put into context, and then the company proposes how to use them to reduce both costs and carbon footprint. Data is collected automatically from online meters, from the energy supplier's system - or the client can enter it manually. In the app everything is combined into a single, clear whole. The solution helps increase production efficiency, stop unwanted leaks and detect hidden faults.

Advantages compared to current solutions:

- Cost reduction: 5-25%.

Other advantages:

- An automated energy management system (no human errors, no chaotic tables, no random information);
- The solution connects everything into a single view;
- It gives data context, visualises them, and manages energy consumption.



Contact: Alena Poláková, alena.polakova@uvptechnicom.sk

Low-cost and secure smart building management solution (hardware and software) that can save up to 30% of energy consumption



Summary:

This end-to-end IoT solution measures, pilot controls and optimises energy consumption related to heating. The technology based on real time monitoring (temperature, current humidity, CO2, complex internal and external air quality...), pilots wireless thermostatic valves. It can anticipate weekends and Holidays with automatic monitoring up to a pre-defined temperature with no possibility (as an option) to manually force temperature upward.

Advantages compared to current solutions:

- 20 to 30% savings on energy bills;
- Ready to use infrastructure: Limited deployment and integration costs, the solution is wireless and preconfigured. Installation can be done by a technician;
- No maintenance costs, and limited operations costs through remote service functionality;
- Each room is monitored separately;
- Industry grade proven solution.

The company has implemented several flagship projects and has concrete use cases of energy saving.

Contact: Amrita SINGH, amrita.singh@cc.lu

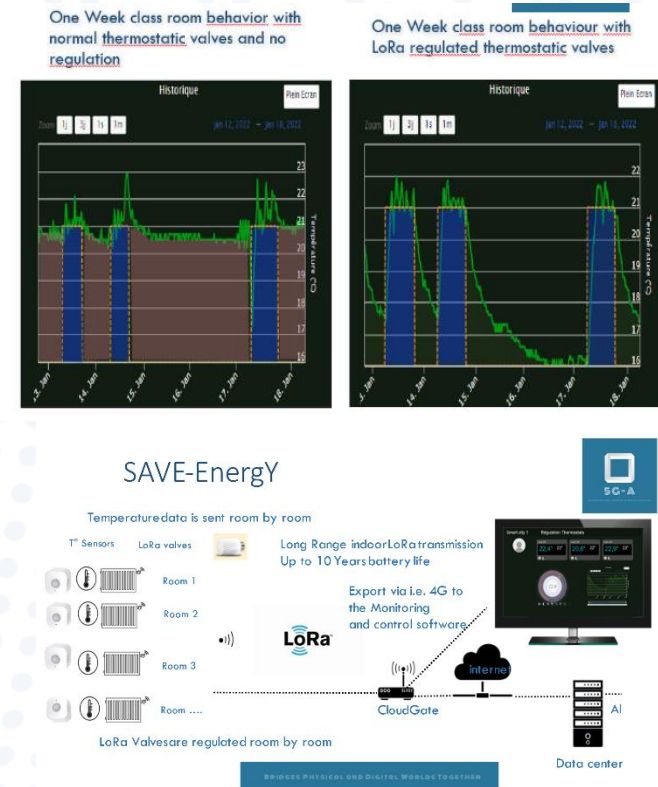

Mobile, self-sufficient drinking water treatment system independent from fossil and external energy sources

Summary:

The product is a mobile, self-sufficient drinking water treatment system, which treats polluted surface water to drinking water in a resource-saving manner. The innovative approach of the system lies in the efficient functionality and many of unique selling points. The company is able to carry out production and assembly on site and prefabrication in its own workshop, as well as all production and assembly preparations. Construction, planning and development work can also be carried out in-house.

Advantages compared to current solutions:

- Independence from fossil and external energy sources to operate the systems. Hydropower, sun or wind are used;
- Treatment of any contaminated surface water - even brackish water becomes treated drinking water;
- Simple operation, which does not require any technical or manual skills - even children can set up and operate the processing systems;
- Low-maintenance conception of the processing plants.



Contact: Claus Vorstadt, cvorstadt@tti-md.de

AI-driven smart energy management system (EMS) that supports the efficient functioning of storage-enabled microgrids improving cost-benefits and return-on-investment



Summary:

UK pioneers in energy storage offer energy management technology for on-site renewables and battery storage. Intelligent control and forecasting enable the energy management system to increase efficiency, reduce waste and save costs. The technology has been deployed in green energy projects at UK shipping ports to cut emissions. The UK company offers commercial agreements to interested partners such as ports, marinas, commercial & industrial, and municipalities.

Advantages compared to current solutions:

- Performance increase of up to 80% over non-optimised energy management systems;
- Additional CAPEX saving through optimised energy system planning;
- Forecasts for on-site loads and generation;
- Enables use of time-variable energy tariffs to optimise costs;
- Works in a behind-the-meter environment;
- Experience of municipal projects, deployment, and business cases.

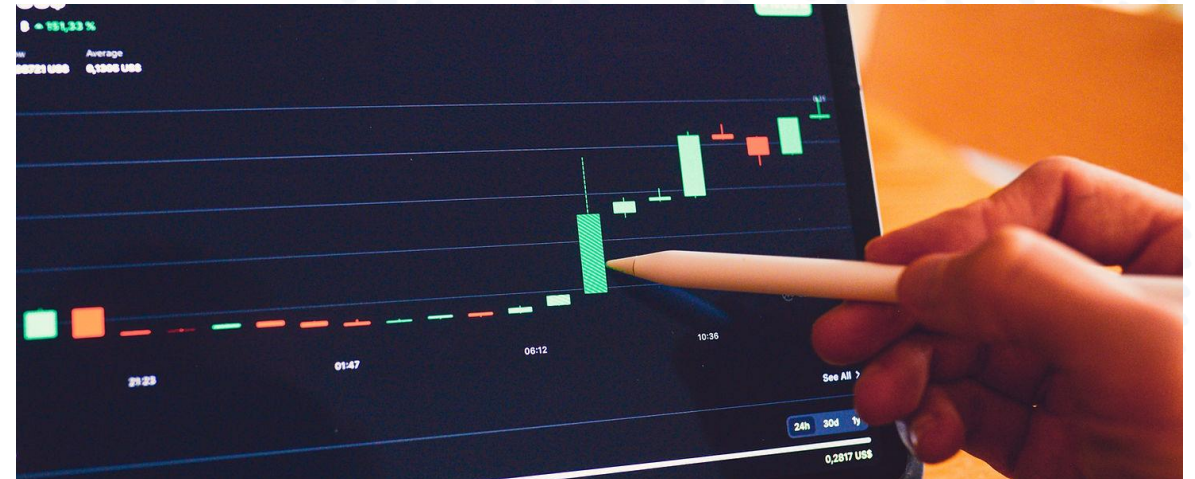

Contact: Dee Temple-Multon, Dee.Temple-Multon@innovateukedge.ukri.org

A digital platform for Renewable Energy Communities (RECs) that improves the way energy users deal with their consumption habits



Summary:

An Italian company has developed a digital platform for Renewable Energy Communities (RECs), the mission is to empower people to foster active participation into smart energy management. This tool helps citizens adapt to new consumption habits for a sustainable future using Technology as a means of aggregation. It is an IoT system that collects data from RECs and, thanks to AI/ML algorithm, sends real-time notifications to coordinate prosumers and consumers for a smart energy consumption.

Advantages compared to current solutions:

Our solution brings the following advantages compared to other platforms to manage energy flows in RECs:

- It will advise citizens when to use shared energy from solar panels installed in the community and save money and CO2 production;
- It makes energy consumers' lives easier;
- Reduction of energy bills by 20%;
- New services for local territory;
- No additional cost for installation, users pay a fraction of what they save.

Other advantages:

- Even people who do not own solar panels will be able to monitor their energy consumption of the REC thanks to this digital platform.

Contact: Federico Molino, f.molino@pie.camcom.it

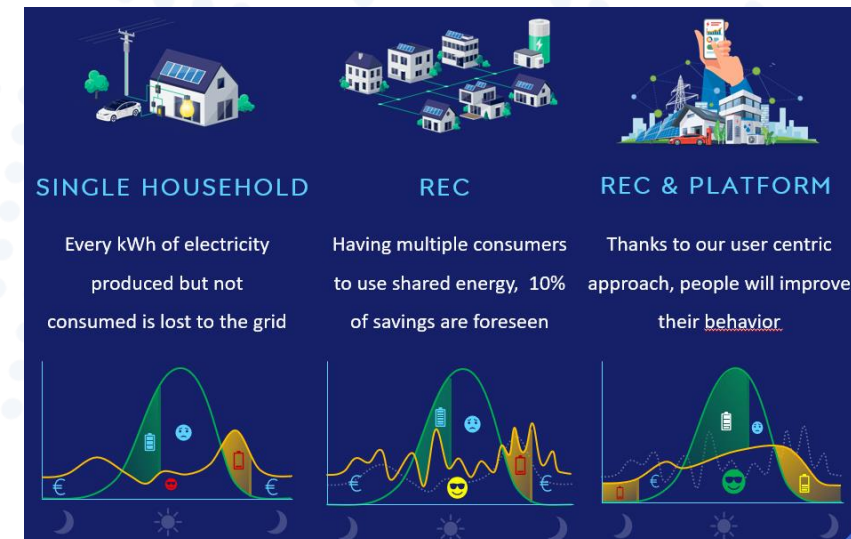

IoT platform for street lighting & smart cities

Summary:

Through a TRL9 digital integrated platform and patented IoT devices, an Italian company helps utility/energy companies, local governments, real estate and other players to improve the energy & operational efficiency and performance of street lighting and buildings. This digital & IoT system collects and processes data & insights, available to customers and policymakers. This solution is offered to companies and municipalities within commercial agreement with technical assistance.

Advantages compared to current solutions:

- energy savings up to 50%;
- reduction of operative costs up to 75% & on-site maintenance up to 70%;
- integration on a single platform of every operation needed to manage & remotely control the infrastructure; access to data & insights;
- unlocked resources and productivity up to 75%;

Other advantages:

- integrate additional smart city services thanks to interoperability of the technology;
- highly impact on environmental and social sustainability of cities.

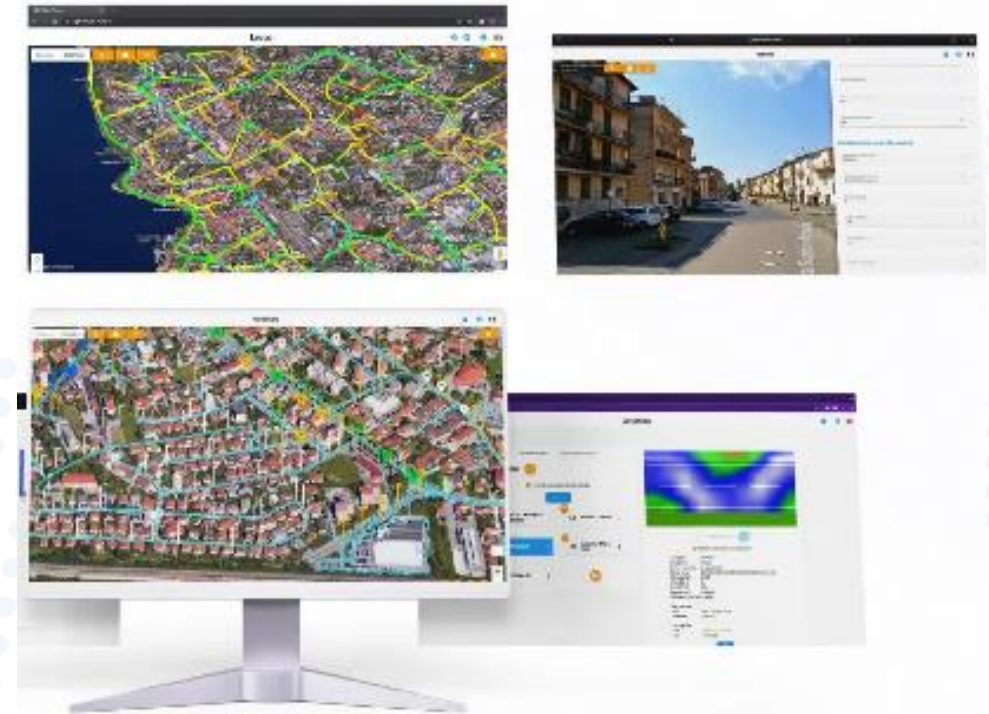

Additional information: <https://een.ec.europa.eu/b2b/profile/88d94d4e-ba03-4653-84e8-018722f7bb12>

Contact: Gabriella Cadeddu, gabriella.cadeddu@finlombarda.it

Reduction of light pollution and increased energy efficiency caused by Smart Street Lighting based on motion detection by radar

Summary:

Street lighting only when needed without sacrifices or a lack of safety. An Austrian enterprise provides a smart solution for making street lighting smart. If a street is empty, the lights are dimmed down to a low level. As soon as moving people or vehicles are detected, the lights are dimmed up. There are more than 1000 sensors installed so far in Austria and Germany. Every luminaire with ZHAGA-socket can be controlled by this solution.

Advantages compared to current solutions:

In comparison to using the luminaires without lighting control, light-on-demand based illumination leads to savings in energy and costs up to 60%. Additionally, the lamp lifetime is extended. Those are two crucial advantages for public authorities.

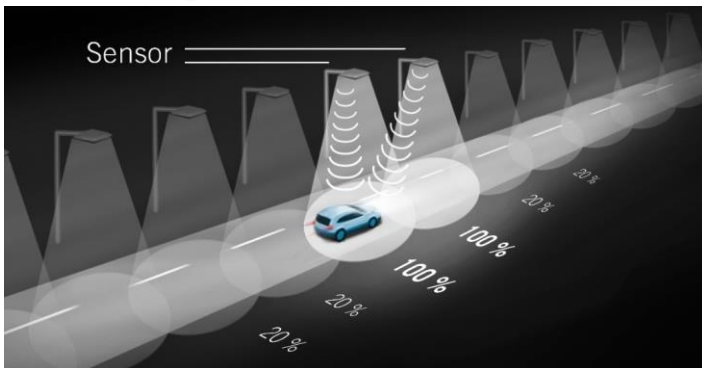

This solution does not only work with rigid dimming profiles, furthermore it is possible to react to the real traffic by detecting the motion. The main application areas are parks, parking spaces, cycle paths, roundabouts and ring roads.

By equipping a luminaire with a bottom-side ZHAGA-socket it is very simple to install the configure the radar modules. So, it is possible to monitor energy statistics, remaining lamp lifetime and functionality of the luminaire –even remotely.

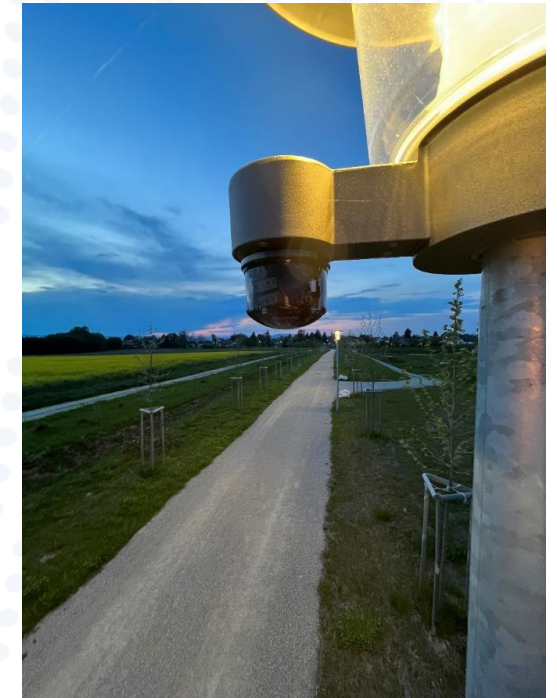

Contact: Michael Kerschbaumer, michael.kerschbaumer@sfg.at

Better planning and operation of district heating networks, saving time, costs and CO2 for new and existing networks

Summary:

In order to meet our climate targets, we need to accelerate the building of new heat networks and the decarbonisation of existing ones. The company is a software company specialized in building tools to improve planning and operation of heat networks. With their platform, energy companies can design, plan and improve their installations intuitively in the browser with just a few clicks, which allows for fast deployment of CO2-neutral communal heat supply.

Advantages compared to current solutions:

Till now, heating grid design and optimisation is a time-consuming and expensive manual task. With the platform, engineers have a central data management platform available and can quickly design heat networks, analyse existing ones and detect efficiency improvements. Communal data on building demand or waste heat potential can be seamlessly integrated and is directly available on the platform. Within current client projects, benefits include:

- cut planning time and costs by min. 30%;
- reduce network planning by at least 6 months.

During network analysis and optimisation, clients

- reduce heat losses by up to 20%;
- leading to cost reduction of heat supply of 150-200€/year per household.

Contact: Michael Kerschbaumer, michael.kerschbaumer@sfg.at

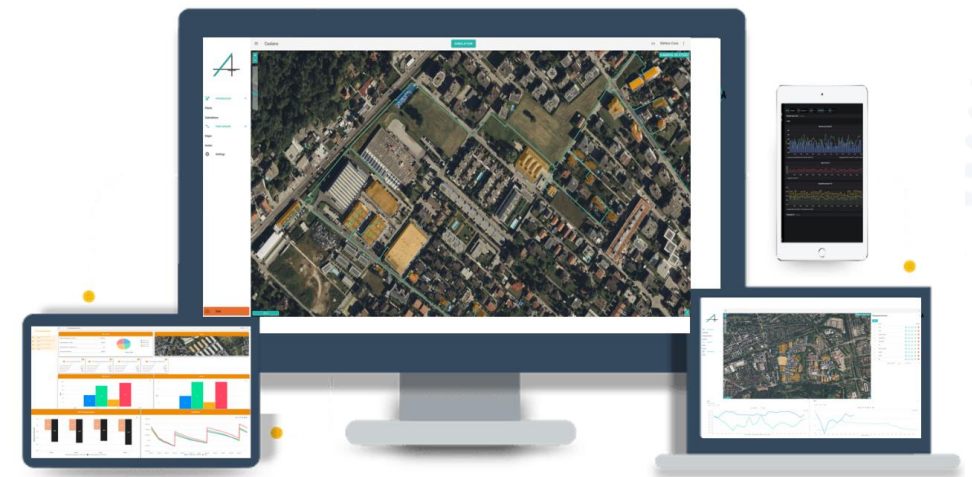

Active flue gas condensation with Absorption Heat Pumps (AHPs) - Increasing the efficiency of biomass district heating systems by >30%



Summary:

Biomass is too valuable to be burned with the efficiencies that are common today! “Active Flue Gas Condensation” - as developed by an Austrian SME - recovers the high amount of latent heat from humid biomass flue gas. Efficiency increases up to 40% can be shown in existing references in Austria. Cold water produced by the AHP cools down the flue gas condenser, thus recovering large amounts of energy from condensing the water vapor.

Advantages compared to current solutions:

Absorption Heat Pumps (AHP's) use the heat from biomass combustion as driving energy for the heat pump process. The electricity consumption is less than 1% of the delivered energy. The typical efficiency increase for biomass heating plants reaches 25-30%, for biomass cogeneration plants 15-20%. The payback for district heating plants between 2-5 MW grid load is usually 5-10 years. For bigger systems, the payback can be less than 2 years.

Other advantages:

- Producing 30% more heat from a certain amount of biomass means:
- A significant reduction of cost!;
- Reduction of biomass usage and reduction of exhaust gases;
- The biomass storage on site can supply the consumers 30% longer than before;
- Less truck loads, less fuel logistic, less ash, ...;
- Condensation removes particles from the flue gas, thus supporting the function of other flue gas filters.

Contact: Michael Kerschbaumer, michael.kerschbaumer@sfg.at

Optimisation platform to maximise renewable energy's and battery systems' profit, by combining the most accurate forecast data with cutting-edge reinforcement learning AI

Summary:

The company's optimization platform consolidates all flexible assets, including batteries, flexible processes, aggregated assets and more, into one central Multi-Market Optimisation.

The platform utilises the company's:

- 1) renewable energy forecasts (wind & solar);
- 2) market forecasts (mFRR, aFRR, FCR-N, FCR-D, FFR) and
- 3) reinforcement learning-based automated trading.

The platform helps to make quick and accurate decisions in real-time, to allocate energy to the most profitable markets at any given time.

Advantages compared to current solutions:

The company's optimisation platform enables allocating energy to the right market at the right time, maximising the profits of the battery investment. The key benefit is optimisation across all markets: the AI-model considers the most profitable combinations of ancillary and wholesale markets while simultaneously taking into account battery wear and SoC-optimization.

The platform utilises cutting-edge reinforcement learning techniques that enable it to learn and adapt continuously to changing market dynamics and customer requirements. This ensures that the company's clients consistently receive optimal energy management strategies that evolve in real-time, adapting to changing market conditions. With multi-market optimisation, it is possible to get 2-3 times more profit from energy storages through their whole lifecycle.

Contact: Mari Kivinen, mari.kivinen@turkubusinessregion.com

B2B digital marketplace of green energy



Summary:

Spanish company has developed a digital platform powered by multi-dimensional innovations which provides an alternative to the electricity market where corporates can procure green energy directly from renewable projects, at lower prices, through bankable power purchase agreements (PPAs) which can be contracted online. The platform has been tested in pilot projects, is live now and has several clients, and still being improved.

Advantages compared to current solutions:

- Savings in contracting costs (can be greater than 50%);
- Less time required to negotiate/close the PPA (3 vs 12 months);
- Savings in energy costs (up to 50% vs market price).

The platform offers commercial/JV agreements to developers of renewable projects and to project financiers. Their target clients are renewable energy suppliers and buyers, and any kind of SME or industry interested in improve their energy efficiency.

Other advantages:

- Achievement of sustainability goals;
- Cost stabilisation (less exposure to high/volatile energy prices);
- No specialised in-house capabilities required;
- Strong PPAs which allow project owners to get financing to build the generation facilities;
- Alignment with strategic priority of the EU to implement a quick deployment of renewables to cut down our dependence on (imported) fossil fuels and to make energy affordable again.

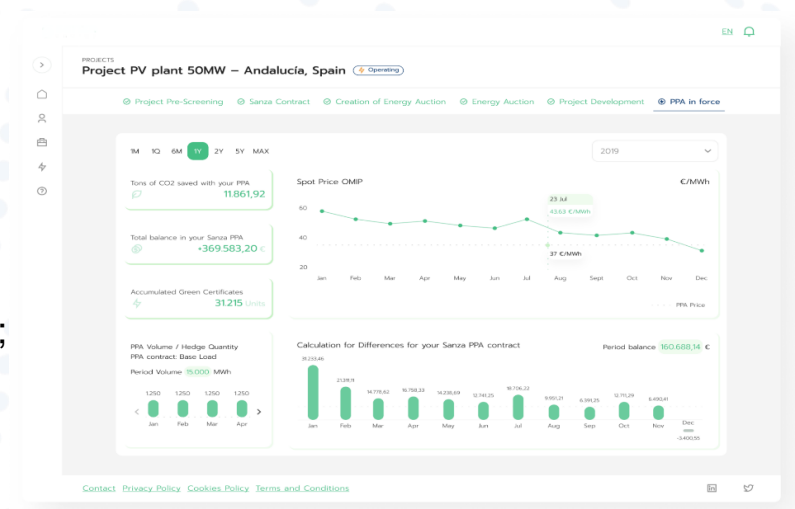

Contact: Mercedes Lecea, mercedes.lecea@madrimasd.org

Hybrid modular streetlight serving as a public charging point

Summary:

An Italian company has developed a hybrid modular smart pole/streetlight that uses sun and wind does not need to be grid-connected, with remote control and a high level of customisation. With a total power output of almost 2kW and storage up to 10kWh it's a small power generator able to provide 24-48-220V power to different devices. The company is seeking for commercial agreements with technical assistance and joint venture agreements to enter new foreign markets.

Advantages compared to current solutions:

- Cost reduction: 20%;
- Performance increase: 40%.

Other advantages:

- Self-contained and energy self-sufficiency, with the use of dual renewable sources sun and wind;
- The pole is free from positioning limits, is a safe and reliable container for all the electronics and can be customised and configured upon needs;
- A high level of customisation with interoperability between; sensors, IoT devices, security cameras, emergency calls, 5G connection devices, LED lights and presence sensors, drone charger, e-bike charger, plus others;
- Remote control and monitoring of the energy use via a web dashboard;
- Modular system to which bigger turbines and solar panels can be added to increase power output.



Additional information: <https://een.ec.europa.eu/b2b/profile/7d0861a8-0eb4-4489-9cdb-017f9cf7f547>

Contact: Marianna Mucci, m.mucci@pie.camcom.it

A real-time optimisation and control technology to accelerate the energy transition

Summary:

A British company has developed an adaptable, digital solution for the power grid, that provides coordinated real-time control and adaptive optimisation of energy assets. The architecture is suitable for digital substations, demonstrating interoperability with modern, legacy and cloud systems. The company offers commercial agreements to utilities, system operators, energy service companies, and distributed energy resources (DER) vendors and owners.

Advantages compared to current solutions:

Deployment of the solution to 100 primary substations (average capacity 50 MVA):

- Annual cost reduction due to savings from reinforcements: £100m;
- Annual savings from mitigating disconnections and network unavailability: £20m.

Deployment of the solution to a typical small-scale microgrid:

- Annual cost savings: 25%;
- Annual CO2 footprint reduction: 11%.

Other advantages:

Reduced OPEX for system operators (decreased network losses, etc.), additional renewables penetration, realisation of flexibility (enables revenues), while it is the only solution that integrates all types of assets from any manufacturer across the world.

Contact: Nghia Tran, nghia.tran@innovateukedge.ukri.org

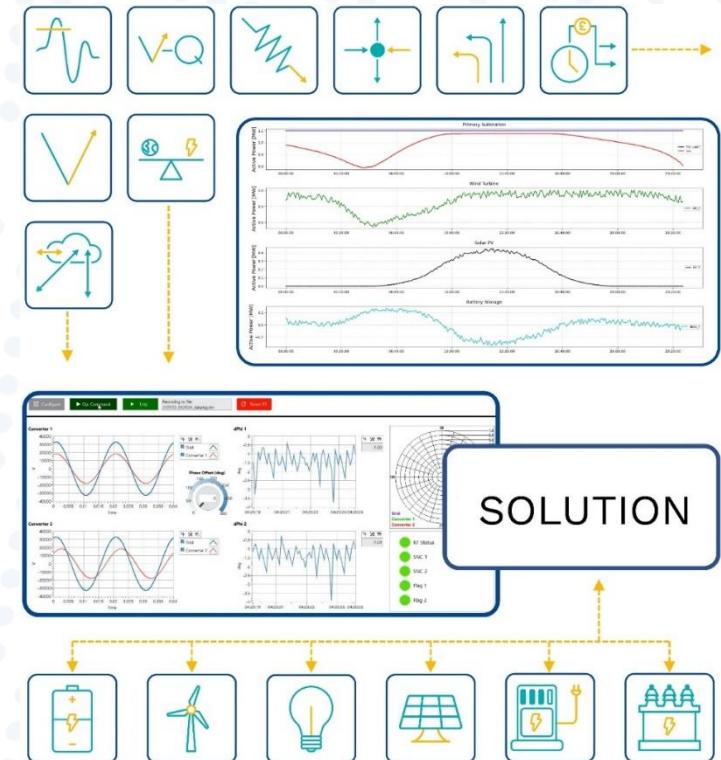

Energy Efficiency for Electricity Production for Industrial Processes

Improving energy efficiency in production of renewable
energy

Improving energy efficiency in industrial processes to
reduce energy use

Innovative heating technology that converts motive power (rotational input energy) to clean thermal energy as heated fluids, for use in domestic, agricultural or industrial premises, and hot fluid applications for industry (processing, cleaning etc.)

Summary:

UK company has developed an innovative renewable heating technology that integrates with a motive power system. The technology delivers exceptional efficiency when converting input energy into usable heat. A cost-effective space and water heating solution for domestic, industrial and agricultural premises. The technology delivers highly efficient conversion of wind or waterpower directly in to heat without the need for expensive voltage conditioning electronics.

Advantages compared to current solutions:

- Delivers heat with zero carbon emissions;
- Independently verified to deliver 99%+ energy conversion efficiency;
- Avoids the use of both combustion processes and electricity;
- Utilises Magnetic fields to convert motive power to heat;
- Large product range for application in small homes to industrial-scale sites;
- Simple, clean renewable heat for a huge variety of uses and fixed or portable solutions;
- Clean, portable and safe delivery of heated fluids;
- Enables renewable energy economics such that install cost and increases in efficiency can render otherwise uneconomic projects viable.



Contact: Andrew Phillips, Andrew.Phillips@innovateukedge.ukri.org

HYPE (Artificial Intelligence for Hydro Power Management)

Summary:

Industrial IoT (internet of things) platform for the remote control and remote monitoring of hydroelectric plants. The solution is based on cloud technology and aims to guarantee a level of reliability and security comparable to that offered by human control. It achieves this with automated detection of anomalies in the plant via the use of advanced machine learning (ML), and through the adoption of best practices in the IoT field.

Advantages compared to current solutions:

- Cost reduction: 15%.

Other advantages:

- Cloud technology supports management costs to be reduced, making the creation of micro-plants more sustainable;
- High-performance and innovative solution for the centralised management of plants located on a large geographical scale;
- Application of AI in order to predict and identify physical events that could affect the functioning of the plant (i.e. debris flows, turbidity and colouration of the water, etc.)



Contact: Federico Molino, f.molino@pie.camcom.it

Company specialising in technologies which enable coastal communities to access low-cost, modular and floating renewable energy generation



Summary:

UK company specialising in development and deployment of innovative and modular products which enable low-cost floating renewable energy projects. The products can be used to provide community-owned and off-grid renewable energy platforms which enable local energy generation and storage. The modules are constructed in the UK and transported globally by rail and sea. Modules are then assembled locally at the destination and towed to deployment locations with no requirement for specialist vessels.

Advantages compared to current solutions:

- An innovative concept for rapid construction of large floating platforms using modular designs;
- Provision of high-density energy to coastal communities without underwater cables;
- Balancing of local energy grid systems, optimisation of the 'energy mix' and peak demand;
- Modular design enables construction in remote areas with limited infrastructure;
- Designed for operation and maintenance by local communities;
- Improved quality of life and new opportunities for commercial enterprises in poor areas.



Contact: Jayne Codling, Jayne.Codling@innovateukedge.ukri.org

Cutting-edge AI platform for operational control and efficiency in power generation, utilities and manufacturing sectors



Summary:

UK company offers technology to industrial energy facilities and operators to improve operational efficiency via their AI-powered 'digital twin' platform which provides insights to plant operation and performance without huge investment. An AI platform for wind, solar, water, and nuclear energy utilities, this company work with clients to increase efficiency, reduce waste, reduce emissions and improve safety with AI.

Advantages compared to current solutions:

- 20% Reduction in operational and maintenance costs with an optimised maintenance strategy;
- Reduce operational downtime;
- Reduce total emissions;
- Reduce energy consumption;
- Increase safety and improve processes and procedures.

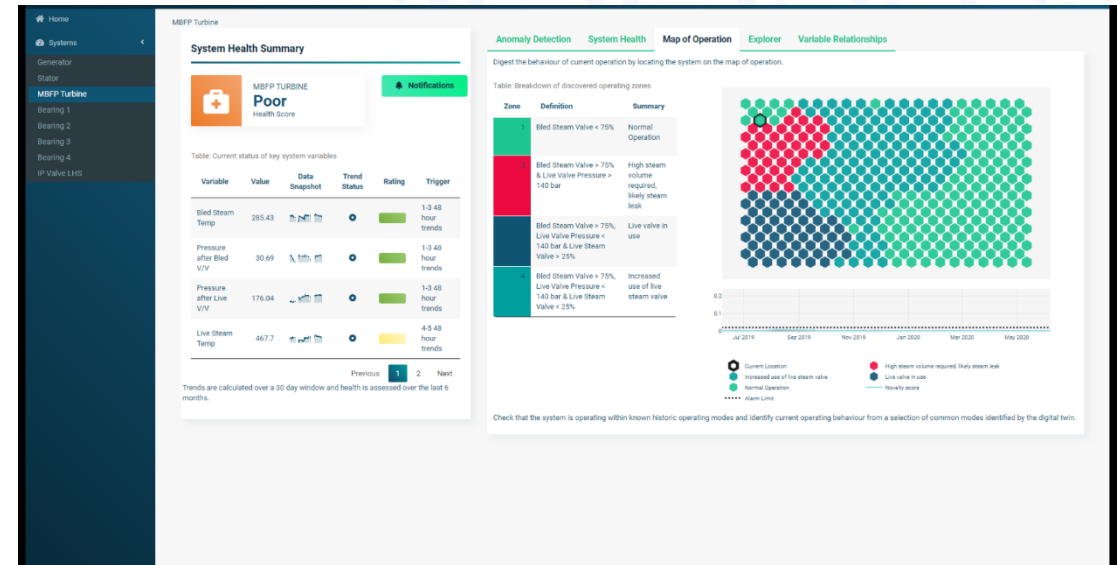

Contact: Jayne Codling, Jayne.Codling@innovateukedge.ukri.org

3D manufacturing technology unlocking resource efficiency and design freedom in mass production

Summary:

A new, Swedish, patented 3D manufacturing technology manufacturing complex profiles with varying topologies and cross-sections in one production step. That is, a part with indents, protrusions, channels and other defined geometric features all in one pass without the need for expensive and energy demanding processing. It is validated for aluminum, plastics, rubber, ceramics, composites and biocomposites. The technology requires minimal upfront investment and integrates with existing production lines.

Advantages compared to current solutions:

- Cost reduction: 80%.

Other advantages:

- Based on extrusion and 100% compatible with existing extrusion lines;
- Each tool is custom designed and built for the customer application and material;
- Combining the freedom of 3D with the speed of 2D;
- Proved application areas are solar panels, thermal windows, bumper beams, heat exchangers, fuel cell plates, EV battery modules, etc.;
- 14 granted patent families from the US in West to Japan in East.

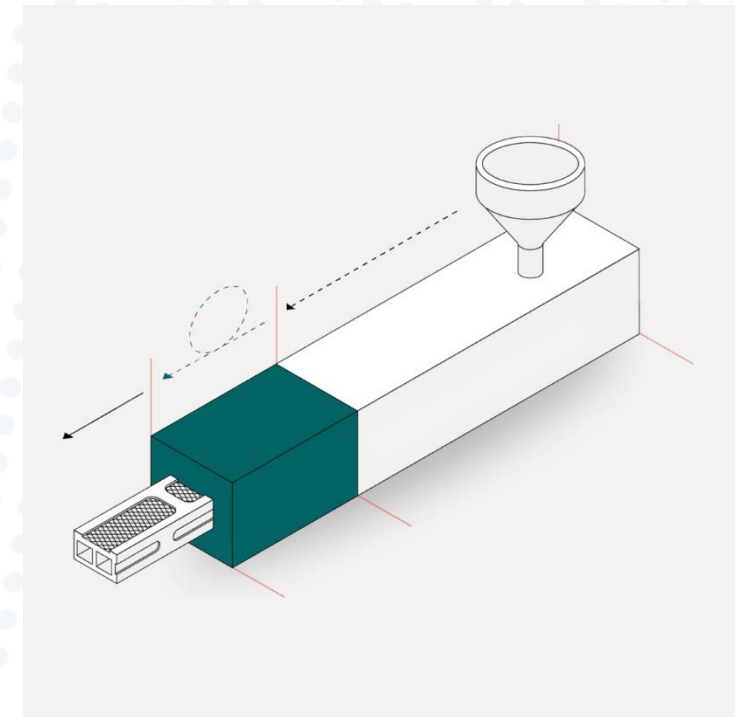

Contact: Lars-Ake Isaksson , lars-ake.isaksson@ltubusiness.se

Solution for recycling old dust particular filters and catalytic converters using innovative technology

Summary:

The technology, developed by the Bulgarian corporation is an innovative one and is a part of its circular solutions for recycling using dust particular filters and catalytic converters of internal combustion engines and industrial installations. The offered recycling solution is based on patented method of combustion of oxy-hydrogen gas mixture.

Advantages compared to current solutions:

- The cost of consumables is about 90% lower, compared to the solutions using heating.
- The price of the recycling process is 50 to 80% lower, compared to the price of new items.

Other advantages:

- The treated items are up to 99% recycled;
- The technology does not use any chemicals and is environmentally friendly;
- There are no chemical deposits left after the procedure is done;
- The technology allows for cleaning of the existing filters and converters instead of buying new ones;
- The consumables are only water and electricity.

Contact: Mina Denkova, minadenkova@res-cluster.com

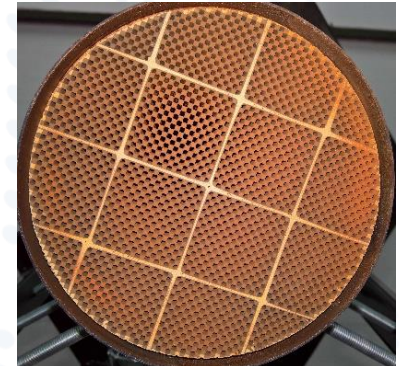

Unleashing AI for meteorological and energy forecasts to wind farms operators: the next gen forecast platform for renewable operators

Summary:

This multisource forecast services platform is focused on giving support and contributing to the decision-making process within the renewable energies industry. Developed by a team of data scientists and meteorologists, it leverages AI to provide with accurate meteorological and energy forecasts to wind farm operators thus empowering the role of the wind energy in the energy market.

Advantages compared to current solutions:

It presents a high usability (available on web platform and mobile app). It is a dynamic tool that is constantly improving (compared to other market's static solutions). The tool's predictions present an adequate accuracy (both its predictions for makeup energy offers in the different electricity markets, as well as its meteorological predictions for O&M activities) that can significantly reduce the operative costs of renewable energy plants.

Other advantages:

- Wind power forecasting service for all circumstances (e.g., recently built wind farms without historical data, offshore projects, PV plants, etc.);
- Tailored solutions to the client needs;
- 6 cutting-edge Machine Learning models;
- Confidence intervals to estimate forecast's uncertainties;
- Access to dynamics maps visualiser.

Contact: María García, maria.garcia@fundecyt-pctex.es

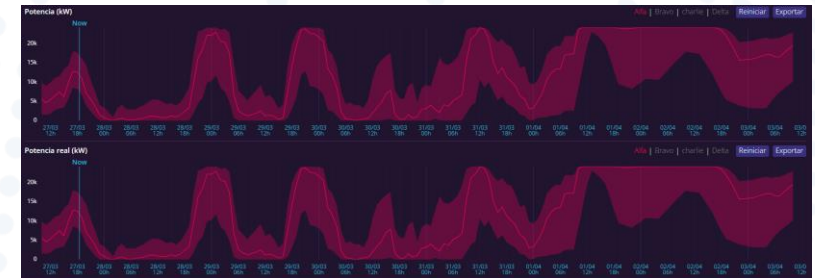

Wind data analysis, wind resource assessment, and wind farm layout and optimisation software in one interface

Summary:

Complete and exhaustive wind energy software, which possesses features directly with wind resource assessment (WRA) calculations, and wind farm modelling and project development at any given stage. Moreover, its compatibility is flexible while working with other software, therefore, allowing users easy access to share and compare information. The software provides solutions to promoters, engineering consultancies, wind resource assessment departments, financial departments, and more.

Advantages compared to current solutions:

The unique feature is to have all wind resource assessment steps in one interface, which saves time for yield assessment engineers. Moreover, the software requires no external programs while maintaining the availability to load several file formats, depending on user's needs.

Having all the necessary modules on to calculate a site's wind resource, design a wind farm, and estimate Annual Energy Produced (AEP) and all project costs on the same interface, it saves lot of time for the WRA team. It also reduces project's cost, with a lower software price delivering all needed information to energy assessment engineers.

Other advantages:

- Download reanalysis data (ERA5, MERRA-2, and more) directly;
- Analyse wind data within diverse modules;
- Calculate on- and offshore wind resource assessments in with both lineal & CFD models;
- Designing site's layout, study the AEP, and features within the micro-siting module;
- Estimate financial aspects of the project.

Contact: María García, maria.garcia@fundecyt-pctex.es

“See beyond” covers are designed to reduce the aesthetic impact of solar panels and protect and extend their lifespan

Summary:

An Italian startup develops and manufactures a special full customisable and recyclable sticker to cover PV panels. The solution allows the integration of solar panels everywhere, also in areas with special regulation to protect the landscape, city centre and historical centre. In addition, it protects the PV panel from external events. The product is already tested in real environments. The company offer commercial agreements to solar panel manufacturers, distributors, installers and energy utilities.

Advantages compared to current solutions:

- Solution to integrate any PV panels in a building with a suitable technology to improve solar energy adoption everywhere in line with the EU mandatory by 2029;
- Cost reduction: 5%;
- Performance increase: 15% (in winter season on vertical application).



Other advantages:

- Customisable aesthetics;
- Extended applications also on photovoltaic facades;
- Decarbonisation of the advertising sector with the creation of new forms of revenue and reduced payback time.



Contact: Paola Tolin, p.tolin@to.camcom.it

Saving energy, resources and costs in industry with method and engineering AI

Summary:

A German company systematically achieves robust products & stable processes in industry with the Robust Design method and an AI system whose algorithm is internationally patented. From product development through industrialisation and series production to maintenance, energy or costs can be saved from 6 to 60 per cent. The method and the AI system can be used across all industries, have been awarded with a Resource Efficiency Prize and have already proven themselves in around 300 projects.

Advantages compared to current solutions:

- Project examples from application throughout the product life cycle:
- Series launch & tool making: Energy reduction: 6–10 %, Cost & resource reduction: 30-60%;
- Material replacements on series: energy reduction: 12%, Cost & resource reduction: 30–60%;
- Series production of complex parts: energy reduction: 14%, cost & resource reduction: 50%.

Other advantages:

- Small samples are sufficient for predictive modelling;
- Complex interactions are predictable for quality and maintenance;
- AI calculates new nominals and tolerances as best settings for sustainable quality;
- Engineering AI controls and steers quality and offers solutions in real time.

Contact: Sonja Angloher-Reichelt, angloher@bayern-innovativ.de



Heat recovery from flue gases with tailormade solutions for SMES and craft businesses

Summary:

A German SME offers gas heat exchangers to recover waste heat from flue gases from incineration units and heating boilers. Firing installations from wood-burning stoves via baking ovens up to plants for process heat fed with wooden or still fossil fuels are examples for heat sources. Areas of sustainable application are biomass combustion plants e. g. operated in heating network or in SMEs such as joineries or garden centres to recycle own biowaste, but also in craft businesses and in industry.

Advantages compared to current solutions:

The potential of the waste heat in the flue gas of combustion plants is often unused but easy to capture:

- Heat exchangers can recover an additional 5% to 10%;
- Compact design, especially for dusty flue gas, enable sustainably fed biomass fired systems;
- Modular design scalable from 10 kW up to e. g. 1200 kW;
- Patented maintenance free bimetallic driven guide plates conduct the flue gas for highest efficiencies;

- Corrosion free stainless-steel construction for low maintenance and low flow resistance;
- Vertical, horizontal or oblique mounting with low installation effort;
- Available for both new and retrofit applications with a short payback period;
- One stop shop for flue gas treatment can provide additional fine dust filter and chimney solutions.

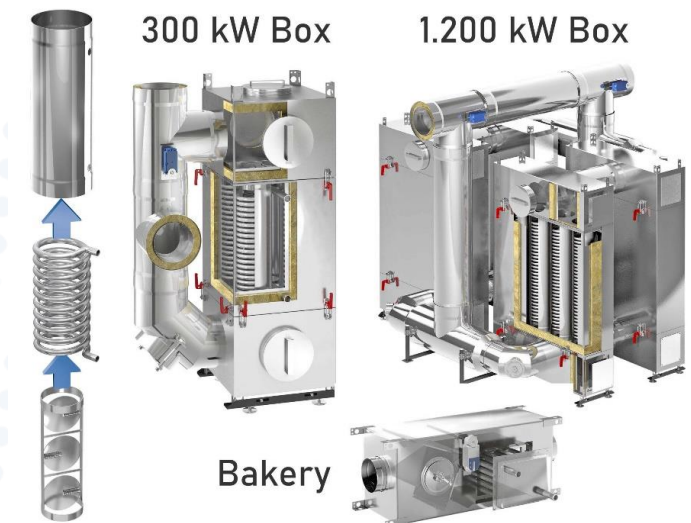

Did you see a solution of interest?

How to get in contact with a company that could provide a solution you are interested in?

1. Have the solution of your interest on your screen.
2. Copy the title of this solution.
3. Click the email address at the bottom of the solution (email program opens with an email) and paste the title of the solution into the title of the email.
4. Write a brief outline of your request, ask for extra clarification or explain what is the need of your company the solution could possibly address.
5. Please add your contact details and send the email.
6. The EEN Advisor you have sent it to will respond to you directly.

If you have any questions, please contact the persons listed at the bottom of the respective profile(s) in the catalogue, or your local Enterprise Europe Network advisor: <https://een.ec.europa.eu/local-contact-points>

More information on the Enterprise Europe Network - the world's largest support network for small and medium-sized enterprises (SMEs) with international ambitions: <https://een.ec.europa.eu/>

Information on funding opportunities

The 55 energy solutions catalogue gathers market-ready energy solutions to be implemented by companies in order to save energy and replace fossil fuel-based processes in view of rising energy prices and climate targets. As the required investments, such as in building renovation, energy efficiency retrofits or replacing fossil fuel-based furnaces, tend to be very capital intensive, companies often need financial support in order to finance these actions.

The EU funding programs almost exclusively target Research, Development and Innovation (R&D&I) actions, thus excluding investments in market-ready solutions. While the EU also invests heavily into investment-based programs, most of these programs are actually installed on national or regional level and companies need to apply at regional/national banks to receive the assistance they need.

BUT...

#EENCanHelp

The Network created the Sustainability Funding Database as a strictly network-internal tool that EEN advisors can use to navigate and understand funding opportunities available at EU, national and regional level. The advisors may share individual information from the database with their clients, using templates that contain the financial instruments relevant for the individual client and include for each of them a short description of their objectives, eligible investments, form of financial support, eligibility and conditions.

Since the EEN has strong connections to regional and national investment banks, the network can also connect its clients with experts that can provide a deep dive into the respective funding scheme.

Please contact your [local EEN advisor](#) for information on national and regional funding programs.

As some funding opportunities can be tapped into on EU level directly, you will find a first overview on the next pages.

If you are interested in R&D&I funding (EU or national/regional level), please also contact your [local EEN advisor](#).

European Energy Efficiency Fund (eeef)

Main purpose of the programme /measure /instrument

Investments in energy efficiency and renewable energy projects

Target applicants

Municipal, local and regional authorities as well as public and private entities acting on behalf of those authorities such as utilities, public transportation providers, social housing associations, energy service companies etc.

Eligible investments

Local infrastructure costs, labor costs, technical expertise,

Funding mechanism/rate

Loans and debt investments

How to apply

Use the Eligibility Check on the eeef website to see if your project is eligible for funding.

Deadlines

Application is possible at any time

More information: <https://www.eeef.lu/eligible-investments.html>

#EENCanHelp

The companies providing the solutions and the developers of this catalogue hope your company will benefit from one or more of the offered technologies or services



een.ec.europa.eu

